

# LAGERLISTE DACHTECHNIK

STAND 07/2023

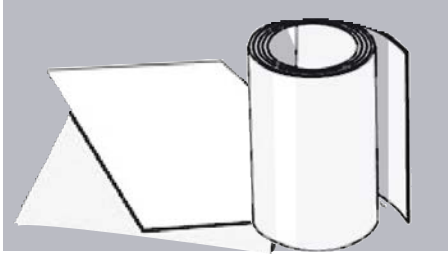

**A**

**TAFELN UND BÄNDER**



**B**

**RINNEN UND ZUBEHÖR**

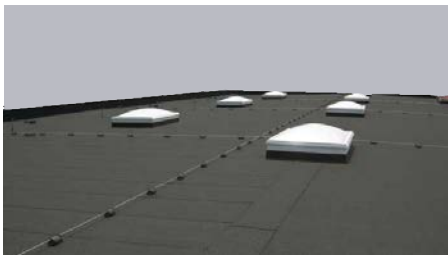

**C**

**FLACHDACH**

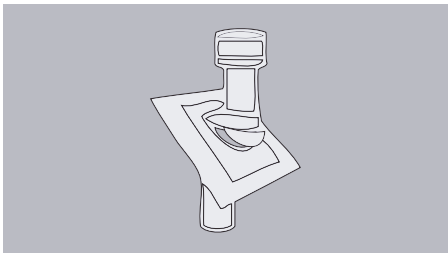

**D**

**STEILDACH**

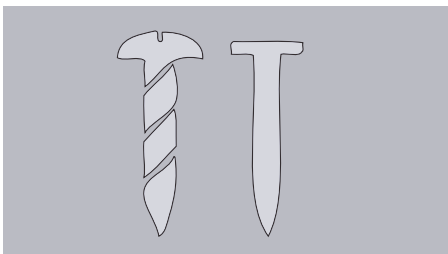

**E**

**BEFESTIGUNGSZUBEHÖR**



**F**

**BESTELLÜBERSICHT**

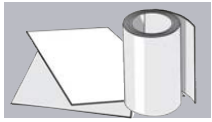

# TAFELN UND BÄNDER

## Inhalt

	Seite
poesis Bänder, Tafeln und Feinblech	A1
Rheinzink Bänder und Tafeln	A2
Quartz, Anthra 	A3
Kupfer Bänder und Tafeln	A4
Aluminium Bänder und Tafeln	A5
Falzit 	A6

## poesis Bänder

## ZINK WALZBLANK



## MAßE

400 x 0,7 mm  
 450 x 0,7 mm  
 500 x 0,7 mm  
 600 x 0,7 mm  
 670 x 0,7 mm  
 1000 x 0,7 mm

## MODELL

60 kg / 30 m  
 67,5 kg / 30 m  
 75 kg / 30 m  
 90 kg / 30 m  
 100 kg / 30 m  
 150 kg / 30 m

## KBN

TBA407PO  
 TBA457PO  
 TBA507PO  
 TBA607PO  
 TBA677PO  
 TBA1007PO

## poesis Tafeln

## ZINK WALZBLANK



## MAßE

1000 x 2000 x 0,7 mm  
 1000 x 3000 x 0,7 mm

## MODELL

## KBN

TTA7PO  
 TTA73PO

## FEINBLECH

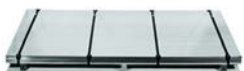

## MAßE

1000 x 2000 x 0,63 mm  
 1000 x 2000 x 0,75 mm  
 1000 x 2000 x 1,00 mm

## MODELL

verzinkt  
 verzinkt  
 verzinkt

## KBN

VTA63  
 VTA75  
 VTA10

## EDELSTAHLTAFEL



## MAßE

1000 x 2000 x 0,6 mm  
 1000 x 2000 x 1,0 mm

## MODELL

blank  
 blank

## KBN

ETA6  
 ETA10

## Rheinzink Bänder

## ZINK WALZBLANK



MAßE	MODELL	KBN
500 x 0,7 mm	100 kg / 41 m	TBA507R
600 x 0,7 mm	100 kg / 34 m	TBA607R
600 x 0,7 mm	1000 kg / 331 m	TBA607RG1
670 x 0,7 mm	100 kg / 31 m	TBA677R
800 x 0,7 mm	100 kg / 25 m	TBA807R
1000 x 0,7 mm	100 kg / 21 m	TBA1007R
1000 x 0,7 mm	1000 kg / 331 m	TBA1007RG1

## VORBEWITTERT BLAUGRAU

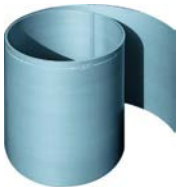

MAßE	MODELL	KBN
500 x 0,7 mm	100 kg / 41 m	TVBA507
600 x 0,7 mm	100 kg / 34 m	TVBA607
600 x 0,7 mm	1000 kg / 331 m	TVBA607G1
670 x 0,7 mm	100 kg / 31 m	TVBA677
1000 x 0,7 mm	100 kg / 21 m	TVBA1007

## VORBEWITTERT SCHIEFERGRAU



MAßE	MODELL	KBN
500 x 0,7 mm	100 kg / 41 m	TVSBA507
600 x 0,7 mm	100 kg / 34 m	TVSBA607
1000 x 0,7 mm	100 kg / 20 m	TVSBA1007

## Rheinzink Tafeln



MAßE	MODELL	KBN
1000 x 2000 x 0,7 mm	Walzblank	TTA7R
1000 x 3000 x 0,7 mm	Walzblank	TTA73R
1000 x 2000 x 0,7 mm	vb. blaugrau	TTA7VB
1000 x 3000 x 0,7 mm	vb. blaugrau	TTA73VB
1000 x 2000 x 0,7 mm	vb. schiefergrau	TTA7VBS

## Bänder

## VORBEWITTERT QUARTZ



MAßE	MODELL	KBN
600 x 0,7 mm	100 kg / 34 m	TQBA607AF
670 x 0,7 mm	100 kg / 31 m	TQBA677A

## Tafeln

## VORBEWITTERT QUARTZ



MAßE	MODELL	KBN
1000 x 2000 x 0,7 mm		TQTA7A

## Bänder



## VORBEWITTERT ANTHRA



MAßE	MODELL	KBN
670 x 0,7 mm mit Folie	100 kg   31 m	TABA677AF
1000 x 0,7 mm mit Folie	100 kg   21 m	TABA1007AF

## Tafeln



## VORBEWITTERT ANTHRA



MAßE	MODELL	KBN
1000 x 2000 x 0,7 mm	mit Folie	TATA7AF

## Bänder

## KUPFER



## MAßE

500 x 0,6 mm  
 600 x 0,6 mm  
 600 x 0,7 mm

## MODELL

82 kg / 30 m  
 95 kg / 30 m  
 112 kg / 30 m

## KBN

KBA506  
 KBA606  
 KBA607

## Tafeln

## KUPFER



## MAßE

1000 x 2000 x 0,6 mm  
 1000 x 2000 x 0,7 mm

## MODELL

## KBN

KTA6  
 KTA7

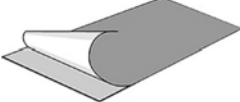

## Aluminium Tafeln

ALUMINIUM			
	MAßE	MODELL	KBN
	1000 x 2000 x 0,8 mm	blank	ATA8
	1000 x 2000 x 0,8 mm	anthrazitgrau	ATA8AZ
	1000 x 2000 x 0,8 mm	dolomitweiß	ATA8DW
	1000 x 2000 x 1,0 mm	blank	ATA10
	1000 x 2000 x 1,5 mm	blank	ATA15
	1000 x 2000 x 0,7 mm	braun/anthrazit	ATA7BAN

## Prefa Aluminium Tafeln Prefalz

ALUMINIUM			
	MAßE	MODELL	KBN
	1000 x 2000 x 0,7 mm	anthrazit P10 glatt	ATA7AZP10
	1000 x 2000 x 0,7 mm	braun / anthrazit	ATA7BA
	1000 x 2000 x 0,7 mm	hellgrau P10 glatt	ATA7HGP10
	1000 x 2000 x 0,7 mm	prefaweiß P10 glatt	ATA7PWP10

## Prefa Aluminium Bänder Prefalz

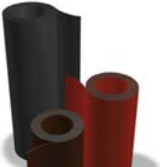
ALUMINIUM			
	MAßE	MODELL	KBN
	500 x 0,7 mm	anthrazit P10 glatt   60 kg	ABA507AZP10
	500 x 0,7 mm	hellgrau P10 glatt   60 kg	ABA507HGP10
	650 x 0,7 mm	anthrazit P10 glatt   60 kg	ABA657AZP10
	650 x 0,7 mm	hellgrau P10 glatt   60 kg	ABA657HGP10
	650 x 0,7 mm	prefaweiß P10 glatt   60 kg	ABA657PWP10



**DAS DACH,  
STARK WIE EIN STIER!**



## Falzit Bänder



ALUMINIUM			
	MAßE	MODELL	KBN
	500 x 0,7 mm	anthrazit struktur	ABA507STAZG
	600 x 0,7 mm	anthrazit struktur	ABA607STAZG

## Aluminium Bänder



ALUMINIUM			
	MAßE	MODELL	KBN
	1000 x 0,8 mm	110 kg/ 50 m	ABA1008

## Lochblech

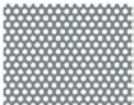
TITANZINK			
	MAßE	MODELL	KBN
	1000 x 2000 x 0,7 mm	5 mm Rundlochung / Rv 5 - 7	TLB57

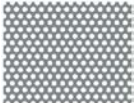
ALUMINIUM			
	MAßE	MODELL	KBN
	1000 x 2000 x 0,8 mm	5 mm Rundlochung /RV 5 - 8 / anthrazit	ALB58AZ
	1000 x 2000 x 1,0 mm	5 mm Rundlochung / Rv 5 - 8	ALB510
	1000 x 2000 x 1,5 mm	5 mm Rundlochung / Rv 5 - 7	ALB515





## Inhalt

	Seite
Bemaßung	B1
Poesis Rinne und Fallrohr walzblank	B2
Rheinzink Rinne und Fallrohr walzblank	B3
Rinnenhalter verzinkt	B4
Rinnenböden Zink	B5
Rinnenwinkel Zink	B6
Einhangstutzen Zink	B7
Dehnungselement, Wasserfangkasten, Laubstop	B8 – B9
Fallrohrbogen Zink	B10
Fallrohrwinkel, Sockelknie, Abzweig, Wassersammler Zink	B11
Standrohrkappe, Verbindungsmuffe Zink	B12
Fallrohrschellen verzinkt	B13
Regenstandrohr, Schellen verzinkt	B14
Rheinzink vorbewittert blaugrau Rinne und Zubehör	B15 - B16
Rheinzink vorbewittert blaugrau Fallrohr und Zubehör	B17 - B18
Kupfer Rinne und Zubehör	B19 - B20
Kupfer Fallrohr und Zubehör	B21 - B23
Prefa P10 Alu Rinne und Zubehör	B24 - B25
Prefa P10 Alu Fallrohr und Zubehör	B26 – B27
LORO-X Stahlabflussrohr	B28 - B30

## Bemaßung halbrund

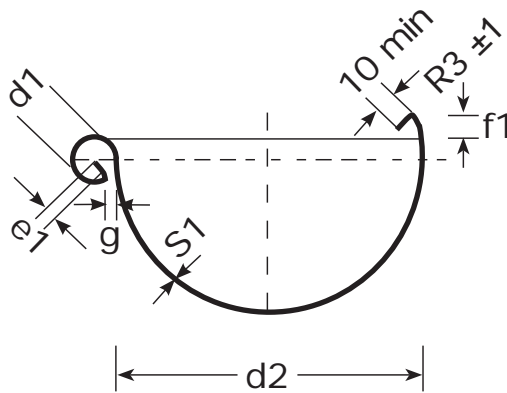

Zuschnitt	d <sub>1</sub>	d <sub>2</sub>	e <sub>1</sub>	f <sub>1</sub>	g	Kupfer			Zink			
10 tlg.,	200	16	80	5	8	5	0,6	0,7		0,65	0,7	
8 tlg.,	250	18	105	7	10	5	0,6	0,7		0,65	0,7	0,8
7 tlg.,	280	18	127	7	11	6	0,6	0,7			0,7	0,8
6 tlg.,	333	20	153	9	11	6	0,6	0,7	0,8		0,7	0,8
5 tlg.,	400	22	192	9	11	6		0,7	0,8			0,8
4 tlg.,	500	22	250	9	21	6		0,7	0,8			0,8

## Bemaßung kastenform

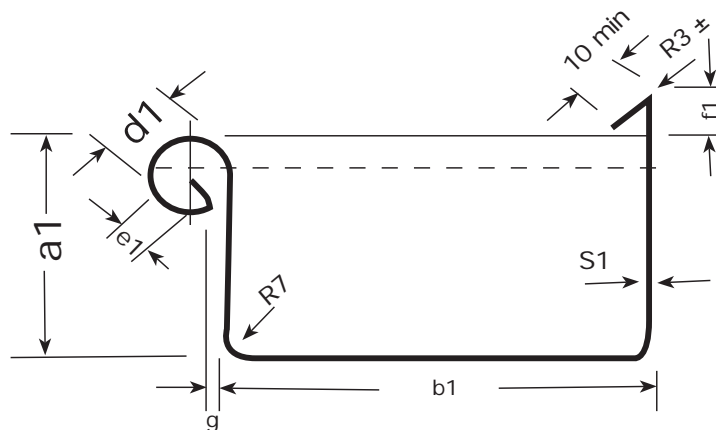

Zuschnitt	a <sub>1</sub>	b <sub>1</sub>	d <sub>1</sub>	e <sub>1</sub>	f <sub>1</sub>	g	Kupfer			Zink			
10 tlg.,	200	42	70	16	5	8	8	0,6	0,7		0,65	0,7	
8 tlg.,	250	55	85	18	7	10	10	0,6	0,7		0,65	0,7	0,8
6 tlg.,	333	75	120	20	9	10	10	0,6	0,7	0,8		0,7	0,8
5 tlg.,	400	90	150	22	9	10	10		0,7	0,8			0,8
4 tlg.,	500	110	200	22	9	20	20		0,7	0,8			0,8

## poesis Rinne

## TITANZINK HALBRUND



MAßE	MODELL	KBN
200 x 3000 x 0,65 mm	10-tlg.	TRI2065M3
250 x 3000 x 0,65 mm	8-tlg.	TRI2565M3
280 x 3000 x 0,7 mm	7-tlg.	TRI287M3
280 x 5000 x 0,7 mm	7-tlg.	TRI287M5
333 x 3000 x 0,7 mm	6-tlg.	TRI337M3
333 x 5000 x 0,7 mm	6-tlg.	TRI337M5
400 x 5000 x 0,8 mm	5-tlg.	TRI408M5

## TITANZINK KASTENFORM



MAßE	MODELL	KBN
200 x 3000 x 0,65 mm	10-tlg.	TKRI2065M3
250 x 3000 x 0,65 mm	8-tlg.	TKRI2565M3
333 x 3000 x 0,7 mm	6-tlg.	TKRI337M3

## Traufstreifen Titanzink



MAßE	MODELL	KBN
200 x 3000 mm	Zuschnitt 135 x 50 x 15 mm	TTR207P
200 x 3000 mm	Zuschnitt 120 x 65 x 15 mm	TTR20765

## Kehlen



MAßE	MODELL	KBN
400 x 3000 mm	Zuschnitt 15 x 185 x 185 x 15 mm 115°	TKE407
500 x 3000 mm	Zuschnitt 15 x 235 x 235 x 15 mm 115°	TKE507P

## poesis Fallrohr

## TITANZINK



MAßE	MODELL	KBN
60 x 2000 x 0,65 mm	10-tlg.	TRG6065
76 x 2000 x 0,65 mm	8-tlg.	TRG7665P
80 x 2000 x 0,65 mm	8-tlg.	TRG8065
87 x 2000 x 0,65 mm	7-tlg.	TRG8765P
87 x 3000 x 0,65 mm	7-tlg.	TRG8765PM3
100 x 2000 x 0,65 mm	6-tlg.	TRG10065
100 x 3000 x 0,65 mm	6-tlg.	TRG10065M3
120 x 2000 x 0,7 mm	5-tlg.	TRG1207

## Rheinzink Rinne

## TITANZINK HALBRUND



MAßE	MODELL	KBN
280 x 3000 x 0,7 mm	7-tlg.	TRI287M3R
280 x 5000 x 0,7 mm	7-tlg.	TRI287M5R
333 x 3000 x 0,7 mm	6-tlg.	TRI337M3R
333 x 5000 x 0,7 mm	6-tlg.	TRI337M5R

## Rheinzink Fallrohr

## TITANZINK



MAßE	MODELL	KBN
87 x 2000 x 0,65 mm	7-tlg.	TRG8765R
100 x 2000 x 0,65 mm	6-tlg.	TRG10065R
100 x 3000 x 0,65 mm	6-tlg.	TRG10065M3R

**RHEINZINK®**

## Rinnenhalter LempHirz

## VERZINKT HALBRUND



MAßE	MODELL	KBN
200 x 25 x 4 mm	10-tlg. mit 2 Federn	VRH20254LH
250 x 25 x 4 mm	8-tlg. mit 2 Federn	VRH25254LH
280 x 30 x 4 mm	7-tlg. mit 2 Federn	VRH28304LH
333 x 30 x 5 mm	6-tlg. mit 2 Federn	VRH33305LH
400 x 30 x 5 mm	5-tlg. mit 2 Federn	VRH40305LH

## VERZINKT KASTENFORM



MAßE	MODELL	KBN
200 x 25 x 4 mm	10-tlg. mit 2 Federn	VKRH20254LH
250 x 25 x 4 mm	8-tlg. mit 2 Federn	VKRH25254LH
333 x 30 x 5 mm	6-tlg. mit 2 Federn	VKRH33305LH

## Rinnenhalterstifte

## VERZINKT



MAßE	MODELL	KBN
4,2 x 65 mm	verzinkt	VRHS4265
4,2 x 80 mm	verzinkt	VRHS4280

## Rinnenhalter Stirnbrettmontage

## HALBRUND



MAßE	MODELL	KBN
250 mm	8-tlg. verzinkt	VRH25A
280 mm	7-tlg. verzinkt	VRH28A
333 mm	6-tlg. verzinkt	VRH33A

## poesis Rinnenboden

ZINK HALBRUND			
	MAßE	MODELL	KBN
	200 mm	10-tlg. universal zum falzen	TRB20
	200 mm	10-tlg. links	TRB20LP
	200 mm	10-tlg. rechts	TRB20RP
	250 mm	8-tlg. links	TRB25LP
	250 mm	8-tlg. rechts	TRB25RP
	280 mm	7-tlg. universal zum falzen	TRB28
	280 mm	7-tlg. links	TRB28LP
	280 mm	7-tlg. rechts	TRB28RP
	333 mm	6-tlg. universal zum falzen	TRB33
	333 mm	6-tlg. links	TRB33LP
	333 mm	6-tlg. rechts	TRB33RP
	400 mm	5-tlg. links	TRB40LP
	400 mm	5-tlg. rechts	TRB40RP

## Grömo Rinnenboden

ZINK KASTENFORM			
	MAßE	MODELL	KBN
	200 mm	10-tlg. links	TKRB20L
	200 mm	10-tlg. rechts	TKRB20R
	250 mm	8-tlg. links	TKRB25L
	250 mm	8-tlg. rechts	TKRB25R
	333 mm	6-tlg. links	TKRB33L
	333 mm	6-tlg. rechts	TKRB33R

## Rheinzingk Rinnenboden

ZINK HALBRUND			
	MAßE	MODELL	KBN
	250 mm	8-tlg. links	TRB28LR
	250 mm	8-tlg. rechts	TRB28RR
	333 mm	6-tlg. links	TRB33LR
	333 mm	6-tlg. rechts	TRB33RR



GRÖMO



## poesis Rinnenwinkel

### ZINK HALBRUND

	MAßE	MODELL	KBN
	200 mm	außen 10-tlg.	TWA20P
	200 mm	Innen 10-tlg.	TWI20P
	250 mm	außen 8-tlg.	TWA25P
	250 mm	Innen 8-tlg.	TWI25P
	280 mm	außen 7-tlg.	TWA28P
	280 mm	Innen 7-tlg.	TWI28P
	333 mm	außen 6-tlg.	TWA33P
	333 mm	Innen 6-tlg.	TWI33P
	400 mm	außen 5-tlg.	TWA40P
	400 mm	Innen 5-tlg.	TWI40P

## Grömo Rinnenwinkel

### ZINK HALBRUND

	MAßE	MODELL	KBN
	200 mm	außen 10-tlg.	TWA20GR
	200 mm	Innen 10-tlg.	TWI20GR
	250 mm	Innen 8-tlg.	TWI25GR
	400 mm	außen 5-tlg.	TWA40GR
	400 mm	Innen 5-tlg.	TWI40GR

## Grömo Rinnenwinkel

### ZINK KASTENFORM

	MAßE	MODELL	KBN
	200 mm	außen 10-tlg.	TKWA20
	200 mm	Innen 10-tlg.	TKWI20
	250 mm	außen 8-tlg.	TKWA25
	250 mm	Innen 8-tlg.	TKWI25
	333 mm	außen 6-tlg.	TKWA33
	333 mm	Innen 6-tlg.	TKWI33

## Rinnenverbinder

### ZINK

	MAßE	MODELL	KBN
	280 mm	7-tlg.	TRVB28
	333 mm	6-tlg.	TRVB33
	400 mm	5-tlg.	TRVB40

## poesis Rinneneinhangstutzen

### TITANZINK HALBRUND



MAßE	MODELL	KBN
250 / 76 mm	8-tlg. Abgang 76 mm halbrund	TEG2576P
280 / 80 mm	7-tlg. Abgang 80 mm halbrund	TEG2880P
280 / 87 mm	7-tlg. Abgang 87 mm halbrund	TEG2887P
333 / 100 mm	6-tlg. Abgang 100 mm halbrund	TEG33100P
400 / 120 mm	5-tlg. Abgang 120 mm halbrund	TEG40120P

## Grömo Rinneneinhangstutzen

### TITANZINK HALBRUND



MAßE	MODELL	KBN
200 / 60 mm	10-tlg. Abgang 60 mm halbrund	TEG2060
250 / 60 mm	8-tlg. Abgang 60 mm halbrund	TEG2560
250 / 76 mm	8-tlg. Abgang 76 mm halbrund	TEG2576G
250 / 80 mm	8-tlg. Abgang 80 mm halbrund	TEG2580
280 / 76 mm	7-tlg. Abgang 76 mm halbrund	TEG2876
280 / 80 mm	7-tlg. Abgang 80 mm halbrund	TEG2880GN
280 / 87 mm	7-tlg. Abgang 87 mm halbrund	TEG2887G
333 / 76 mm	6-tlg. Abgang 76 mm halbrund	TEG3376
333 / 80 mm	6-tlg. Abgang 80 mm halbrund	TEG3380
333 / 87 mm	6-tlg. Abgang 87 mm halbrund	TEG3387
333 / 100 mm	6-tlg. Abgang 100 mm halbrund	TEG33100GN
400 / 100 mm	5-tlg. Abgang 100 mm halbrund	TEG40100

## Grömo Kastenrinneneinhangstutzen

### TITANZINK KASTENFORM



MAßE	MODELL	KBN
200 / 60 mm	10-tlg. Abgang 60 mm	TKE2060
250 / 76 mm	8-tlg. Abgang 76 mm	TKE2576
250 / 80 mm	8-tlg. Abgang 80 mm	TKE2580
333 / 100 mm	6-tlg. Abgang 100 mm	TKE33100

## Lötstutzen

### TITANZINK HALBRUND



MAßE	MODELL	KBN
60 mm	10-tlg. halbrund	TRST60
60 mm	10-tlg. kastenform	TKRST60
76 mm	8-tlg. halbrund	TRST76
87 mm	7-tlg. halbrund	TRST87
100 mm	6-tlg. halbrund	TRST100

## Dehnungselement

### TITANZINK HALBRUND



MAßE	MODELL	KBN
250 mm	8-tlg. einseitig vulkanisiert	TDE25V
280 mm	7-tlg. einseitig vulkanisiert	TDE28V
333 mm	6-tlg. einseitig vulkanisiert	TDE33V
400 mm	5-tlg. einseitig vulkanisiert	TDE40V

## Dehnungselement

### TITANZINK KASTENFORM



MAßE	MODELL	KBN
250 mm	8-tlg. einseitig vulkanisiert	TKDE25V
333 mm	6-tlg. einseitig vulkanisiert	TKDE33V

## Wasserfangkasten

### TITANZINK



MAßE	MODELL	KBN
76 mm	8-tlg. mittlerer Auslauf	TRK76
87 mm	7-tlg. mittlerer Auslauf	TRK87
100 mm	6-tlg. mittlerer Auslauf	TRK100P
120 mm	5-tlg. mittlerer Auslauf	TRK120P

## Dunsthäube

### TITANZINK



MAßE	MODELL	KBN
100 mm	6-tlg.	TDH100

## Band Dehnungsausgleicher

### TITANZINK



MAßE	MODELL	KBN
260 x 3000 mm	Zink	TDB263

## Laubstop

HD PE			
	MAßE	MODELL	KBN
	150 x 3000 mm	schwarz für 6/5 tlg. Rinne	LBST150

## Rinnensieb

EDELSTAHL			
	MAßE	MODELL	KBN
	75 / 80 mm	für Abgang 8-tlg.	ELS80
	85 / 90 mm	für Abgang 7-tlg.	ELS90
	100 mm	für Abgang 6-tlg.	ELS100

## Halbwulst

TITANZINK			
	MAßE	MODELL	KBN
	76 mm	8-tlg.	THW76
	87 mm	7-tlg.	THW87
	100 mm	6-tlg.	THW100

## poesis Fallrohrprovisorium

	MAßE	MODELL	KBN
	60-120 mm	Rolle a 100 m	FRP60150

## poesis Fallrohrbogen

### TITANZINK



MAßE	MODELL	KBN
60 mm	10-tlg. 60 Grad	TB6060
60 mm	10-tlg. 72 Grad	TB6072
76 mm	8-tlg. 40 Grad	TB7640
76 mm	8-tlg. 60 Grad	TB7660
76 mm	8-tlg. 72 Grad	TB7672
76 mm	8-tlg. 85 Grad	TB7685
80 mm	8-tlg. 60 Grad	TB8060
80 mm	8-tlg. 72 Grad	TB8072
80 mm	8-tlg. 85 Grad	TB8085
87 mm	7-tlg. 40 Grad	TB8740
87 mm	7-tlg. 60 Grad	TB8760
87 mm	7-tlg. 72 Grad	TB8772
87 mm	7-tlg. 85 Grad	TB8785
100 mm	6-tlg. 40 Grad	TB10040
100 mm	6-tlg. 60 Grad	TB10060
100 mm	6-tlg. 72 Grad	TB10072
100 mm	6-tlg. 85 Grad	TB10085
120 mm	5-tlg. 40 Grad	TB12040
120 mm	5-tlg. 60 Grad	TB12060
120 mm	5-tlg. 72 Grad	TB12072
120 mm	5-tlg. 85 Grad	TB12085

## Grömo Fallrohrbogen

### TITANZINK



MAßE	MODELL	KBN
60 mm	10-tlg. 40 Grad	TB6040
60 mm	10-tlg. 85 Grad	TB6085
76 mm	8-tlg. 60 Grad	TB7660G
76 mm	8-tlg. 72 Grad	TB7672G
80 mm	8-tlg. 72 Grad	TB8072G
87 mm	7-tlg. 72 Grad	TB8772G
87 mm	7-tlg. 60 Grad	TB8760G
100 mm	6-tlg. 72 Grad	TB10072G
120 mm	5-tlg. 60 Grad	TB12060G

## Fallrohrwinkel

### TITANZINK



MAßE	MODELL	KBN
60 mm	10-tlg. 87 Grad	TW6087
87 mm	7-tlg. 87 Grad	TW8787
100 mm	6-tlg. 87 Grad	TW10087

## Sockelknie

### TITANZINK



MAßE	MODELL	KBN
76 mm	8-tlg. Ausladung 60mm	TSK76
87 mm	7-tlg. Ausladung 60mm	TSK87
100 mm	6-tlg. Ausladung 60mm	TSK100
120 mm	5-tlg. Ausladung 60mm	TSK120

## Fallrohrabzweig

### TITANZINK



MAßE	MODELL	KBN
60 x 60 mm	10-tlg. x 10-tlg. 72 Grad	TAZ6072
76 x 76 mm	8-tlg. x 8-tlg. 72 Grad	TAZ7672
80 x 80 mm	8-tlg. x 8-tlg. 72 Grad	TAZ8072
87 x 60 mm	7-tlg. x 10-tlg. 72 Grad	TAZ876072
87 x 76 mm	7-tlg. x 8-tlg. 72 Grad	TAZ877672
87 x 87 mm	7-tlg. x 7-tlg. 72 Grad	TAZ8772
100 x 60 mm	6-tlg. x 10-tlg. 72 Grad	TAZ1006072
100 x 76 mm	6-tlg. x 8-tlg. 72 Grad	TAZ1007672
100 x 87 mm	6-tlg. x 7-tlg. 72 Grad	TAZ1008772
100 x 100 mm	6-tlg. x 6-tlg. 72 Grad	TAZ10072

## Regenrohrklappe

### TITANZINK



MAßE	MODELL	KBN
76 mm	8-tlg. mit Laubsieb	TRKL76L
87 mm	7-tlg. mit Laubsieb	TRKL87L
100 mm	6-tlg. mit Laubsieb poesis	TRKL100LP
120 mm	5-tlg. mit Laubsieb	TRKL120L

## Wassersammler

### TITANZINK



MAßE	MODELL	KBN
76 mm	mit Schlauchanschluss-Set	TWS76
87 mm	mit Schlauchanschluss-Set	TWS87
100 mm	mit Schlauchanschluss-Set	TWS100

## Rheinzink Reviso-Schiebefix

TITANZINK			
	MAßE	MODELL	KBN
	76 mm	8-tlg. mit Standrohrkappe 116 mm	TRSF76116R
	87 mm	7-tlg. mit Standrohrkappe 116 mm	TRSF87116R
	100 mm	6-tlg. mit Standrohrkappe 116 mm	TRSF100116R

## Fallrohrreduzierung

TITANZINK			
	MAßE	MODELL	KBN
	87 x 76 mm	7-tlg. x 8-tlg.	TRE8776
	100 x 80 mm	6-tlg. x 8-tlg.	TRE10080
	100 x 87 mm	6-tlg. x 7-tlg.	TRE10087
	120 x 100 mm	5-tlg. x 6-tlg.	TRE120100

## Verbindungsuffe

TITANZINK			
	MAßE	MODELL	KBN
	60 mm	10-tlg.	TVS60
	76 mm	8-tlg.	TVS76
	80 mm	8-tlg.	TVS80
	87 mm	7-tlg.	TVS87
	100 mm	6-tlg.	TVS100
	120 mm	5-tlg.	TVS120

## Standrohrkappe

TITANZINK			
	MAßE	MODELL	KBN
	60 mm	10-tlg. x 116	TST60116
	76 mm	8-tlg. x 116	TST76116
	80 mm	8-tlg. x 116	TST80116
	87 mm	7-tlg. x 116	TST87116
	100 mm	6-tlg. x 116	TST100116
	100 mm	6-tlg. x 150	TST100150
	120 mm	5-tlg. x 150	TST120150



## Fallrohrschellen

VERZINKT			
	MAßE	MODELL	KBN
	60 mm	10-tlg. mit Gewinde M8/M10	VRS60G
	76 mm	8-tlg. mit Gewinde M8/M10	VRS76G
	80 mm	8-tlg. mit Gewinde M8/M10	VRS80G
	87 mm	7-tlg. mit Gewinde M8/M10	VRS87G
	100 mm	6-tlg. mit Gewinde M8/M10	VRS100G
	120 mm	5-tlg. mit Gewinde M8/M10	VRS120G

## poesis insulo Dämmstoffdübel

EDELSTAHL			
	MAßE	MODELL	KBN
	M10 x 100 mm	V2A 5er-Set	POINDSD

## Stockschrauben

VERZINKT			
	MAßE	MODELL	KBN
	M10 x 100 mm	verzinkt VPE 50	CCLSTS10100
	M10 x 120 mm	verzinkt VPE 50	CCLSTS10120
	M10 x 140 mm	verzinkt VPE 25	CCLSTS10140
	M10 x 180 mm	verzinkt VPE 25	CCLSTS10180
	M10 x 200 mm	verzinkt	STS10200
	M10 x 250 mm	verzinkt	STS10250
	M10 x 300 mm	verzinkt	STS10300
	M10 á 50 Stk.	Rosette mit Neopren-Dichtung	ROSETTEM10LH

## Regenstandrohr

STAHL			
	MAßE	MODELL	KBN
	DN 70 x 1000 mm	mit Reinigungsöffnung	VSR70R
	DN 100 x 1000 mm	ohne Reinigungsöffnung	VSR100
	DN 100 x 1000 mm	mit Reinigungsöffnung	VSR100R
	DN 100 x 2000 mm	mit Reinigungsöffnung	VSR1002000R
	DN 125 x 1000 mm	mit Reinigungsöffnung	VSR125R

## Regenstandrohr

GUSS			
	MAßE	MODELL	KBN
	DN 100 x 1000 mm	SML ohne Muffe	MLRSR100

## Standrohr

PE			
	MAßE	MODELL	KBN
	110 mm x 1 m	zinkgrau f. 100mm Fallrohr	PESR110G1M

## Standrohrschelle

VERZINKT			
	MAßE	MODELL	KBN
	DN 100	mit Schlagstift 150 mm	VRS100S
	DN 100	mit Gewinde	VRS100SG
	DN 125	mit Gewinde	VRS125SG
	DN 100	mit Gewinde für SML/GA	VRSML100G
	DN 70	mit Schlagstift	LXRS70
	DN 100	mit Schlagstift für PE	RSK100

## Rheinzink Rinne

### prePATINA BLAUGRAU HALBRUND



MAßE	MODELL	KBN
280 x 3000 x 0,7 mm	7-tlg.	TVRI287M3
333 x 3000 x 0,7 mm	6-tlg.	TVRI337M3
333 x 5000 x 0,7 mm	6-tlg.	TVRI337M5

## Rinnenhalter

### prePATINA BLAUGRAU



MAßE	MODELL	KBN
280 x 25 x 6 mm	7-tlg. zinkummantelt	TUVRH28256K
333 x 25 x 6 mm	6-tlg. zinkummantelt	TUVRH33256K

## Rinnenboden

### prePATINA BLAUGRAU



MAßE	MODELL	KBN
280 mm	7-tlg. links	TVRB28L
280 mm	7-tlg. rechts	TVRB28R
333 mm	6-tlg. links	TVRB33L
333 mm	6-tlg. rechts	TVRB33R

## Dehnungselement

### prePATINA BLAUGRAU

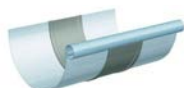

MAßE	MODELL	KBN
333 mm	6-tlg. 260 mm lang	TVDE33

## Rinnenwinkel

## prePATINA BLAUGRAU

	MAßE	MODELL	KBN
	280 mm	7-tlg. außen	TVWA28
	333 mm	6-tlg. außen	TVWA33
	333 mm	6-tlg. innen	TVWI33

## Rinneneinhangstutzen

## prePATINA BLAUGRAU

	MAßE	MODELL	KBN
	280 x 80 mm	7-tlg. auf 80 mm	TVEG2880
	333 x 80 mm	6-tlg. auf 80 mm	TVEG3380
	333 x 100 mm	6-tlg. auf 100 mm	TVEG33



## Rheinzink Fallrohr

### prePATINA BLAUGRAU



MAßE	MODELL	KBN
80 x 2000 x 0,7 mm	8-tlg. geschweißt 2 m	TVRG807
80 x 3000 x 0,7 mm	8-tlg. geschweißt 3 m	TVRG807M3
100 x 2000 x 0,7 mm	6-tlg. geschweißt 2 m	TVRG1007
100 x 3000 x 0,7 mm	6-tlg. geschweißt 3 m	TVRG1007M3

## Rheinzink Fallrohrbogen

### prePATINA BLAUGRAU



MAßE	MODELL	KBN
60 mm	10-tlg. 72 Grad	TVB6072
80 mm	8-tlg. 40 Grad	TVB8040
80 mm	8-tlg. 72 Grad	TVB8072
100 mm	6-tlg. 40 Grad	TVB10040
100 mm	6-tlg. 60 Grad	TVB10060
100 mm	6-tlg. 72 Grad	TVB10072

## Rheinzink Sockelknie

### prePATINA BLAUGRAU



MAßE	MODELL	KBN
100 mm	6-tlg.	TVSK100

## Rheinzink Wasserfangkasten

### prePATINA BLAUGRAU



MAßE	MODELL	KBN
80 mm	220 x 220 mm	TVRK8022
100 mm	220 x 220 mm	TVRK10022

## Rheinzink Regenrohrklappe

### prePATINA BLAUGRAU



MAßE	MODELL	KBN
100 mm	6-tlg. mit Regenrohrklappe	TVRKL100L

## Rheinzink Regensammler

### prePATINA BLAUGRAU



#### MAßE

80 mm  
100 mm

#### MODELL

mit Wasserschlauchset  
mit Wasserschlauchset

#### KBN

TVWS80R  
TVWS100R

## Rheinzink Rohrschelle

### prePATINA BLAUGRAU



#### MAßE

80 mm  
100 mm

#### MODELL

mit M10 Gewinde  
mit M10 Gewinde

#### KBN

TVRS80G  
TVRS100G

## Rheinzink Standrohrkappe

### prePATINA BLAUGRAU



#### MAßE

80 mm  
100 mm

#### MODELL

80 x 116 mm  
100 x 116 mm

#### KBN

TVST80116  
TVST100116

## Rinne

## KUPFER HALBRUND

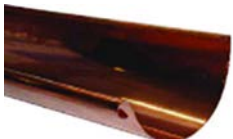
	MAßE	MODELL	KBN
	333 x 3000 x 0,6 mm	6-tlg.	KRI336M3
	333 x 5000 x 0,6 mm	6-tlg.	KRI336M5



## Rinnenhalter

## KUPFER HALBRUND

	MAßE	MODELL	KBN
	280 x 25 x 6 mm	7-tlg. kurz kupferummantelt	KURH28256K
	333 x 30 x 5 mm	6-tlg. Feder kurz	KRH33305K
	333 x 25 x 5 mm	6-tlg. kurz kupferummantelt	KURH33255K

## Rinnenboden

## KUPFER HALBRUND

	MAßE	MODELL	KBN
	333 mm	6-tlg. links	KRB33L
	333 mm	6-tlg. rechts	KRB33R
			



## Dehnungselement

### KUPFER HALBRUND



#### MAßE

280 mm  
333 mm

#### MODELL

7-tlg. einseitig vulkanisiert  
6-tlg. einseitig vulkanisiert

#### KBN

KDE28V  
KDE33V

## Wasserfangkasten

### KUPFER



#### MAßE

100 mm

#### MODELL

6-tlg. mittiger Auslauf

#### KBN

KRK100

## Rinneneinhangstutzen

### KUPFER HALBRUND



#### MAßE

333 x 87 mm  
333 x 100 mm

#### MODELL

6-tlg. Abgang 87 mm  
6-tlg. Abgang 100 mm

#### KBN

KEG3387  
KEG33100P

## VMZINC Fallrohr Kupfer

### KUPFER



#### MAßE

87 x 2000 x 0,6 mm  
100 x 2000 x 0,6 mm

#### MODELL

7-tlg. geschweißt  
6-tlg. geschweißt

#### KBN

KRG876  
KRG1006

## Fallrohrbogen

### KUPFER



#### MAßE

87 mm  
87 mm  
100 mm  
100 mm

#### MODELL

7-tlg. 72 Grad  
7-tlg. 85 Grad  
6-tlg. 72 Grad  
6-tlg. 85 Grad

#### KBN

KB8772  
KB8785  
KB10072  
KB10085

## Fallrohrabzweig

### KUPFER



#### MAßE

100 x 100 mm

#### MODELL

6-tlg. x 6-tlg. 72 Grad

#### KBN

KAZ10072

## Sockelknie

### KUPFER



#### MAßE

87 mm  
100 mm

#### MODELL

7-tlg.  
6-tlg.

#### KBN

KSK87  
KSK100

## Verbindungsstufe

### KUPFER



MAßE

100 mm

MODELL

6-tlg.

KBN

KVS100F

## Regenrohrklappe

### KUPFER



MAßE

87 mm

100 mm

MODELL

7-tlg. m. Laubsieb

6-tlg. m. Laubsieb

KBN

KRKL87L

KRKL100L

## Wassersammler

### KUPFER



MAßE

100 mm

MODELL

6-tlg. zum Stecken mit Schlauch-  
anschluss-Set

KBN

KWS100

## Halbwulst

### KUPFER



MAßE

100 mm

MODELL

6-tlg.

KBN

KHW100

## Standrohrkappe

KUPFER			
	MAßE	MODELL	KBN
	100 mm	6-tlg. x 116 mm	KST100116

## Fallrohrschelle

KUPFER			
	MAßE	MODELL	KBN
	87 mm	7-tlg. mit Gewinde	KRS87G
	100 mm	6-tlg. mit Gewinde	KRS100G

### Prefa Rinne Anthrazit P10

ALUMINIUM			
	MAßE	MODELL	KBN
	333 x 5000 x 0,7 mm	6-tlg. anthrazit halbrund	ARI330AZM1P10

### Prefa Rinnenhalter Anthrazit P10

ALUMINIUM			
	MAßE	MODELL	KBN
	280 x 28 x 7 mm	7-tlg. halbrund	ARH28AZP10
	280 x 28 x 7 mm	7-tlg. kurz halbrund	ARHK28AZP10
	333 x 28 x 7 mm	6-tlg. kurz halbrund	ARHK33AZP106

### Prefa Rinnenboden Anthrazit P10

ALUMINIUM			
	MAßE	MODELL	KBN
	280 mm	rechts und links halbrund	ARB28AZP10
	333 mm	rechts und links halbrund	ARB33AZP10

### Prefa Rinnenwinkel Anthrazit P10

ALUMINIUM			
	MAßE	MODELL	KBN
	333 mm	6-tlg. außen halbrund	AWA33AZP10
	333 mm	6-tlg. innen halbrund	AWI33AZP10

## Rinneneinhangsstutzen Anthrazit P10

## ALUMINIUM



## MAßE

333 mm

## MODELL

6-tlg. Abgang 100 mm halbrund

## KBN

AEG33100AZP10

## Zubehör



## MAßE

4,1 mm

12 ml

## MODELL

Spezialklebeset

Patentniete anthrazit

Ausbesserungslack Anthrazit P10

## KBN

PRSPKL

ANIET41AZ

PRALDP12AZ



DAS DACH,  
STARK WIE EIN STIER!

### Prefa Fallrohr Anthrazit P10

ALUMINIUM			
	MAßE	MODELL	KBN
	80 x 3000 x 0,7 mm	80 mm	AR80AZM3P10
	100 x 3000 x 0,7 mm	6-tlg.	AR100AZM3P10

### Prefa Fallroherschelle Anthrazit P10

ALUMINIUM			
	MAßE	MODELL	KBN
	80 mm	mit M10 Gewinde	ARS80AZP10
	100 mm	mit M10 Gewinde	ARS100AZP10

### Prefa Wasserfangkasten Anthrazit P10

ALUMINIUM			
	MAßE	MODELL	KBN
	100 mm	6-tlg.	ARK100AZP10

### Wasserkubus Anthrazit P10

ALUMINIUM			
	MAßE	MODELL	KBN
	80 mm quadratisch	200 x 200 x 200 mm	ARK80QAZP10WW
	100 mm quadratisch	200 x 200 x 200 mm	ARK100QAZP10WW

### Prefa Fallrohrbogen Anthrazit P10

ALUMINIUM			
	MAßE	MODELL	KBN
	80 mm	72 Grad	AB8072AZP10
	100 mm	6-tlg. 72 Grad	AB10072AZP10

### Prefa Rohrverbinder Anthrazit P10

ALUMINIUM			
	MAßE	MODELL	KBN
	100 mm	6-tlg.	AVS100AZP10

### Prefa Standrohrkappe Anthrazit P10

ALUMINIUM			
	MAßE	MODELL	KBN
	80 mm	80 x 115 mm	AST80115AZP10
	100 mm	6-tlg. x 115 mm	AST100115AZP10



## LORO Abflussrohr

STAHL			
	MAßE	MODELL	KBN
	DN70 x 500 mm	mit 1 Muffe	LXER7050
	DN70 x 1000 mm	mit 1 Muffe	LXER70100
	DN70 x 2000 mm	mit 1 Muffe	LXER70200
	DN70 x 3000 mm	mit 1 Muffe	LXER70300
	DN100 x 500 mm	mit 1 Muffe	LXER10050
	DN100 x 1000 mm	mit 1 Muffe	LXER100100
	DN100 x 2000 mm	mit 1 Muffe	LXER100200
	DN100 x 3000 mm	mit 1 Muffe	LXER100300

## LORO Bogen

STAHL			
	MAßE	MODELL	KBN
	DN70	15°	LXB7015
	DN70	30°	LXB7030
	DN70	45°	LXB7045
	DN70	87°	LXB7087
	DN100	15°	LXB10015
	DN100	30°	LXB10030
	DN100	45°	LXB10045
	DN100	87°	LXB10087

## LORO Abzweig

STAHL			
	MAßE	MODELL	KBN
	DN70	87°	LXA7087
	DN100	87°	LXA10087



## Loro Standrohrkappe

### STAHL



MAßE	MODELL	KBN
DN 70	rund	LXST70
DN 80	rund	LXST80
DN 100	rund	LXST100
DN 100	rund für Rohr mit Außendruckmessser 102 mm	LXST100102
DN 125	rund	LXST125

## Loro Rohrschelle



### STAHL



MAßE	MODELL	KBN
DN 80	mit Gewinde M10/M12	LXDRS80MM
DN 100	mit Gewinde M10/M12	LXDRS100MM

## LORO Muffe

STAHL			
	MAßE	MODELL	KBN
	DN70	Doppelmuffe	LXM70
	DN70	Einschiebemuffe	LXUM70
	DN100	Doppelmuffe	LXM100
	DN100	Einschiebemuffe	LXUM100

## LORO Übergangsröhre

STAHL			
	MAßE	MODELL	KBN
	DN50 x DN70	konzentrisch	LXUK5070
	DN70 x DN100	konzentrisch	LXUK70100

## LORO Anschlussstücke

STAHL			
	MAßE	MODELL	KBN
	DN70	an SML-Rohr DN70	LXAS70ML70
	DN70	an SML/HT/KA-Rohr DN100	LXAS70ML100
	DN100	an HT / KA-Rohr DN100	LXAM100HT
	DN100	an HT / KA-Rohr DN100	LXAS100HTM100
	DN125	an HT / KA-Rohr DN125	LXAS125HTM

## LORO Dichtelement

ELASTOMER			
	MAßE	MODELL	KBN
	DN70	für LORO-Muffe	LXD70
	DN100	für LORO-Muffe	LXD100
	DN125	für LORO-Muffe	LXD125
	DN100	KA-Muffe DN100 auf Loro DN100	LXDKA100

# LORO®

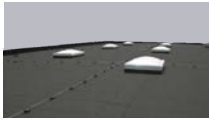

## Inhalt

	Seite
Soprema Bitumenabdichtung	C1
Mogat Bitumenabdichtung	C2
Soprema FPO	C3
Soprema PVC	C3
Soprema Flüssigkunststoff	C3
Elapro Flüssigkunststoff	C4
Poesis Bitumenvoranstrich	C5
Poesis texo plus Flachdachabdichtung	C5
Poesis stricta 	C5
Alwitra Dachbahnen und Zubehör	C6
Bautenschutzmatte, Entwässerungsrost, Kiesfangleiste	C7
Wandanschlussprofil	C7
Poesis ductus 	C8
Poesis cantus Flachdachabschlussprofil	C9-10
Grumbach Gully	C11-C12
Sita Gully	C13-C16
Klöber Flachdacheinlauf und Lüfter	C17
Dämmung	C18-C19

## Soprema Bitumen Dampfsperrbahnen

	MAßE	MODELL	KBN
	1,0 x 5,0 m	AL + V60 S4 Sand / Folie	SOALV6S4TN
	1,0 x 6,0 m	EVA 35 Talkum Folie	SOEVA35
	1,08 x 8,5 m	Vapro vap	SOVAPROVAPN

## Soprema Schweissbahnen Zwischenlage

	MAßE	MODELL	KBN
	1,0 x 10,0 m	G200 DD Sand / Sand	SOG2DDSN
	1,0 x 5,0 m	G200 S4 Sand / Folie	SOG2S4TN
	1,0 x 5,0 m	PYE G200 S4 Sand / Folie	SOPYEG2S4T
	1,0 x 5,0 m	V60 S4 Sand / Folie	SOV6S4TN
	1,0 x 10,0 m	Sopralene Flam 30 D Folie / Folie	SOFLAMD
	1,0 x 7,5 m	Sopralene KS-U Folie /KSP	SOKSUN
	1,0 x 7,5 m	Vapro stixx Folie/ KSP	SOVAPROSTIXX

## Soprema Schweissbahnen Oberlage

	MAßE	MODELL	KBN
	1,0 x 5,0 m	PYE PV200 S5 EN Schiefer	SOPYEPV2S5EN
	1,0 x 5,0 m	Sopralene Flam Jardin S5 Schiefer	SOJARDINS5
	1,0 x 5,0 m	Sopralene Flam Jardin S5 Carbon	SOJARDINS5C
	1,0 x 5,0 m	Sopralene Activa OL	SOACTOLS
	1,0 x 6,0 m	Flam Jardin S4 dunkelbraun	SOJARDINS4BR
	10 kg	Schieferplättchen Schiefer	SOSCHIEFER

## Soprema Bitumen Schalungsbahn

	MAßE	MODELL	KBN
	1,0 x 10,0 m	V 13 Sand / Sand	SOV13

## Mogat Dampfsperre

	MAßE	MODELL	KBN
	1,0 x 5,0 m	V 60 + AL S4 Dampfsperre	ALV6S4MG
	1,0 x 5,0 m	G 200 S4 talkumierte Bitumen Schweißbahn	G2S4TMG
	1,0 x 7,5m	Mogaplan VAL	MGDSV

## Mogat Unterlagsbahn

	MAßE	MODELL	KBN
	1,0 x 10,0 m	Mogafix KSK-U kaltselbstklebend	MGKSKUN

## Mogat Oberlage

	MAßE	MODELL	KBN
	1,0 x 5,0 m	PYE PV200 S5 EN grün beschiefert	PYEPV2S5BGRM
	1,0 x 5,0 m	Rutex Forte Wurzelschutzbahn	MGRUFORTE

## Soprema FLAGON FPO Dachbahn



MAßE	MODELL	KBN
1,05 x 20,0 m	Flagon EP/S 150 trägerlos sandgrau	SOEPS150

## Soprema FLAG /FPO Zubehör



MAßE	MODELL	KBN
1,0 x 2,0 m	Verbundblech 0,6mm Folie 1,2mm sandgrau	SOFLAGV07
3,0 m	Befestigungsschiene verzinkt	SOFLAGS3
2,20 x 50,0 m	Polystervlies 300g/m <sup>2</sup> bohrfest	PVLIES3002250

## Soprema ALSAN Flashing



MAßE	MODELL	KBN
5 kg	QUADRO wurzelfeste Bitumen-PU-Harz-Beschichtung RAL 7012	SOALSANQ7012N
0,25 x 50 m	FLEECE 165 QUADRO Vlies 25 cm	SOALSANQV25
10 l	Alsan 076 Reiniger	SOALSANREIN
1 kg	Beschichtungsmasse Cural Korrosionsschutz für Metalle	SOCURAL1

## ELAPRO Flüssigkunststoff

	MAßE	MODELL	KBN
	5 kg	DACHdicht 1K-CRYL, Seidengrau	ELDD5SG
	6 kg	DACHdicht 1K-SIL, Silbergrau	ELDD6SIG
	0,30 x 50 m	Vlies Rolle 110/m <sup>2</sup> , performiert	ELV30P
		Außenecke Vlies	ELVAE
		Innenecke Vlies	ELVIE
	5 kg	DACHdicht 1K-CRYL, Schwarz	ELDD5S
	6 kg	DACHdicht 1K-SIL, Anthrazit	ELDD6SIA
	2,5 kg	Primer UN transparent	ELHGUN25TN
	2,5 kg	Primer KS transparent	ELPKS25
	1 l	Cleaner transparent	ELC1
	25 cm	Metallgebindeöffner	ELMGO
	10 cm	Nylonrolle Florhöhe ca. 6 mm	ELR010
	10 cm	Nylonrollenbügel	ELROB10
		Vliesschere rostfrei	ELVS

## ELAPRO Quick Repair

	MAßE	MODELL	KBN
	1,5 kg	Reparaturmasse, Steingrau	ELQR1



## poesis Spachtel- und Metallkleber



MAßE	MODELL	KBN
12 kg	Klebe- und Dichtungsmasse	POFISMK12

## poesis Bitumenvoranstrich



MAßE	MODELL	KBN
10 l	schnelltrocknend lösemittelhaltig	POFIVALH10
30 l	schnelltrocknend lösemittelhaltig	POFIVALH30
25 l	Polymer-Bitumenvoranstrich lösemittelfr.	POFIVALH25

## poesis texo plus - Vlies

MAßE	MODELL	KBN
26,5 cm	Vlies Rolle á 50 m	POTPV26550
52,5 cm	Vlies Rolle á 50 m	POTPV5250
105 cm	Vlies Rolle á 50 m	POTPV10550

## poesis stricta



MAßE	MODELL	KBN
6 kg	1K Flüssigkunststoff RAL 7016, lösemittelfrei	POSF6
12 kg	1K Flüssigkunststoff RAL 7016, lösemittelfrei	POSF12
50 m x 30 cm	Vlies 110 g, weiß	POSV30
	Innenecken weiß	POSVIE
	Außenecken weiß	POSVAU
4 kg	Grundierung für Metalle und minerale Oberflächen	POSGM4
4 kg	Grundierung für Kunststoffe	POSGK4
5 L	biobasierter Reiniger	POSR5

## Alwitra Evalon Dachbahnen

	MAßE	MODELL	KBN
	1,05 x 25,0 m	VG 1,5 mm schiefergrau	EVAVG105SG15
	1,55 x 25,0 m	VG 1,5 mm schiefergrau	EVAVG155SG15
	1,05 x 25,0 m	VGSK 1,5 mm schiefergrau	EVAVGSK105SG15
	0,25 x 25,0 m	unkaschiert 1,5 mm schiefergrau	EVA2515SG
	0,33 x 25,0 m	unkaschiert 1,5 mm schiefergrau	EVA3315SG
	0,16 x 25,0 m	unkaschiert 1,5 mm schiefergrau	EVA1615SG
	1,05 x 25,0 m	unkaschiert 1,5 mm schiefergrau	EVA10515SG
	0,33 x 25,0 m	VSKA 1,5 mm schiefergrau	EVA3315SKSG
	0,43 x 25,0 m	VSKA 1,5 mm schiefergrau	EVAVSKA43SG
	0,63 x 25,0 m	VSKA 1,5 mm schiefergrau	EVAVSKA63SG

## Evalon Zubehör

	MAßE	MODELL	KBN
	10 l	Haftgrund SK-L Fass	EVAHGSKL10F
	25 l	Haftgrund SK-L Fass	EVAHGSKL25F
	0,5 l	Quellschweißmittel	ALWITRAQS05
	3,0 l	Quellschweißmittel	ALWITRAQSM3
	2,0 kg	Dachbahnreiniger	ALWITRAREIN
	1,0 x 2,0 m	Verbundblech schiefergrau	EVATASG
		Außenecke Serie W schiefergrau	EVAAEWSG
		Innenecke Serie W schiefergrau	EVAIEWSG

## Evalon Wasserspeier

	MAßE	MODELL	KBN
	DN 70	Typ S mit Anschlusskragen	ALWWSS70
	DN 100	Typ S mit Anschlusskragen	ALWWSS100

## Bautenschutzplatte

### GUMMIGRANULAT



MAßE	MODELL	KBN
2000 x 1000 x 0,6 mm	Bauten- Isolierschutzplatte	BSP6
2000 x 1000 x 0,8 mm	Bauten- Isolierschutzplatte	BSP8
2000 x 1000 x 1,0 mm	Bauten- Isolierschutzplatte	BSP10

## Kiesfangleiste

### ALUMINIUM

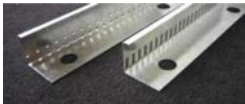

MAßE	MODELL	KBN
60 x 100 x 3000 x 1,5 mm	höhenverstellbar mit Folie	AKL15610300VMN

## poesis Wandanschlußprofil

### ALUMINIUM



MAßE	MODELL	KBN
60 x 3000 mm	vorgelocht	AWAP60

## Briel Wandabschlussprofil RAL 7016



### ALUMINIUM



MAßE	MODELL	KBN
60 x 3000 mm	vorgelocht anthrazit	AWAP60AZ
4,5 x 35 mm	Spenglerschrauben RAL 7016 TX20	SPENG453515AZ
4,5 x 45 mm	Spenglerschrauben RAL 7016 TX20	SPENG454515AZ
4,5 x 60 mm	Spenglerschrauben RAL 7016 TX20	SPENG456015AZ
4,5 x 80 mm	Spenglerschrauben RAL 7016 TX20	SPENG458015AZ

## poesis ductus Rinne

VERZINKT	MAßE	MODELL	KBN
	100 mm	Rinne inkl. Gitter 30/10	PODURI10031VZ

## poesis ductus Stellfüße

VERZINKT	MAßE	MODELL	KBN
	70 - 85 mm	höhenverstellbar für Rinne 100/150 mm	PODUH1SRIVZ
	100 - 130 mm	höhenverstellbar für Rinne 100/150 mm	PODUH3SRIVZ

## poesis ductus Verbinder

VERZINKT	MAßE	MODELL	KBN
	100 mm	für Rinne 100 mm	PODUVRI100VZ

## poesis ductus Endkappe

VERZINKT	MAßE	MODELL	KBN
	100 mm	für Rinne 100 mm	PODUERI100VZ

## poesis cantus Alu – Flachdachabschlussprofil

ALUMINIUM			
	MAßE	MODELL	KBN
	100 x 5000 mm	einteilig AL Mg Si 0,5mm F22	AFDP100P
	130 x 5000 mm	einteilig AL Mg Si 0,5mm F22	AFDP130P
	150 x 5000 mm	einteilig AL Mg Si 0,5mm F22	AFDP150P
	200 x 5000 mm	einteilig AL Mg Si 0,5mm F22	AFDP200P

## poesis cantus Innen- und Außenecke

ALUMINIUM			
	MAßE	MODELL	KBN
	100 mm	Außenecke 225 x 225 mm x 90°	AFDPWA100P
	100 mm	Innenecke 330 x 330 mm x 90°	AFDPWI100P
	130 mm	Außenecke 225 x 225 mm x 90°	AFDPWA130P
	130 mm	Innenecke 330 x 330 mm x 90°	AFDPWI130P
	150 mm	Außenecke 225 x 225 mm x 90°	AFDPWA150P
	150 mm	Innenecke 330 x 330 mm x 90°	AFDPWI150P
	200 mm	Außenecke 225 x 225 mm x 90°	AFDPWA200P
	200 mm	Innenecke 330 x 330 mm x 90°	AFDPWI200P

## poesis cantus Flachdachabschlussprofil Zubehör

ALUMINIUM				
	MAßE	MODELL	KBN	
	100 mm	Stoßverbinder Alu-Natur	AFDPSV100P	
	130 mm	Stoßverbinder Alu-Natur	AFDPSV130P	
	150 mm	Stoßverbinder Alu-Natur	AFDPSV150P	
	200 mm	Stoßverbinder Alu-Natur	AFDPSV200P	
			Klemmschiene	AFDPKSP
			Winkel-Klemmschiene	AFDPKSWP

## poesis cantus Alu – Endkappe

ALUMINIUM			
	MAßE	MODELL	KBN
	100 mm	paar links und rechts	AFDPEND100
	130 mm	paar links und rechts	AFDPEND130
	150 mm	paar links und rechts	AFDPEND150
	200 mm	paar links und rechts	AFDPEND200

## poesis cantus Alu - Flachdachabschlussprofil

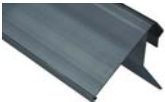
ALUMINIUM			
	MAßE	MODELL	KBN
	130 x 5000 mm	RAL 7016	AFDP130PAZ

## poesis cantus Innen- und Außenecke RAL 7016

ALUMINIUM			
	MAßE	MODELL	KBN
	130 mm	Außenecke 225 x 225 mm x 90°	AFDPWA130PAZ
	130 mm	Innenecke 330 x 330 mm x 90°	AFDPWI130PAZ

## poesis cantus Endkappen RAL 7016

ALUMINIUM			
	MAßE	MODELL	KBN
	130 mm	paar links und rechts	AFDPEND130AZ

## poesis cantus Stoßverbinder RAL 7016

ALUMINIUM			
	MAßE	MODELL	KBN
	130 mm	für Flachdachabschluss 130 mm	AFDPSV130PAZ

## Grumbach Universal-Gully

### WÄRMEGEDÄMMT



MAßE	MODELL	KBN
DN 70	mit Klemmflansch waagrecht u. Kiesfang	GRWK70
DN 100	mit Klemmflansch senkrecht u. Kiesfang	GRSK100
DN 100	mit Klemmflansch waagrecht u. Kiesfang	GRWK100

## Grumbach Sanierungs-Gully

### WÄRMEGEDÄMMT



MAßE	MODELL	KBN
DN 100	mit Bitumenmanschette senkrecht	GRSS88
DN 125	mit PVC-Anschlussmanschette	GRSS103P

## Grumbach Kompakt-Kragen-Gully

### WÄRMEGEDÄMMT



MAßE	MODELL	KBN
DN 70	mit Bitumenmanschette senkrecht	GRS70B
DN 100	mit Bitumenmanschette senkrecht	GRS100B
16 cm	Aufstockelement mit Bitumenmanschette	GRASE16B

## Grumbach Attika-Balkongully

### WÄRMEGEDÄMMT



MAßE	MODELL	KBN
DN 70	mit Bitumenmanschette	GRA70B
DN 100	mit Bitumenmanschette	GRA100B
DN 50	mit Bitumenmanschette	GRA50
DN 100	mit PVC Manschette	GRABE100P
DN 70	mit PVC Mansch. f. Notüberlauf	GRABN70P
D100	mit PVC Mansch. f. Notüberlauf	GRABN100P

## Grumbach Attika-Notüberlauf

### WÄRMEGEDÄMMT



MAßE	MODELL	KBN
DN 70	mit Bitumenmanschette mit 55cm Rohr	GRANL70B
DN 50	mit PVC Manschette	GRANL50P
DN 70	mit PVC Manschette	GRANL70P
DN 100	mit PVC Manschette	GRANL100P

## Grumbach Balkon-Gully



MAßE	MODELL	KBN
DN 50	senkrecht mit Bitumenmanschette	GRBS50B

## Grumbach Aufstockelement

### WÄRMEGEDÄMMT

WÄRMEGEDÄMMT	MODELL	KBN
	mit Klemmflasch	GRBASE
	mit Klebekragen Bitumen	GRASEGB

## DALLMER Aufsatzrahmen



### WÄRMEGEDÄMMT

WÄRMEGEDÄMMT	MAßE	MODELL	KBN
	150 x 150 mm	SES 10	DALLARSES10





## Sita Trendy Dach-Gully



	MAßE	MODELL	KBN
	DN70	senkrecht mit Bitumenmanschette	STDS70B
	DN100	senkrecht mit Bitumenmanschette	STDS100B
	DN100	abgewinkelt mit Bitumenmanschette	STDA100B
	DN100	senkrecht mit PVC Manschette	STDS100PVC
	DN100	abgewinkelt mit PVC Manschette	STDA100PVC
	DN125	senkrecht mit Bitumenmanschette	STDS125B

## Sita Trendy Aufstockelement



	MAßE	MODELL	KBN
	150 mm	universal mit Bitumenmaschette	STASE150B
	220 mm	mit Bitumenmanschette	STASE220B
	220 mm	mit PVC Manschette	STASE220PVC
	220 mm	mit Tectofin-Sondermanschette	STASE220T

## Sita More Anstaeuelement



	MAßE	MODELL	KBN
	25 - 105 mm	für Sita Trendy	SMASE105

## Sita Indra



## HAUPTENTWÄSSERUNGSSET



MAßE	MODELL	KBN
DN70	abgewinkelt Bitumen	SHSA70BPD

## Sita Easy Plus Attikagully



MAßE	MODELL	KBN
DN70	mit geradem Festflansch mit Bitumenmanschette	SEAG70B
DN100	mit geradem Festflansch mit Wolfin-IB-Sonderman.	SEPAG100IB

## Sita Easy Attikagully



## AUS PUR WÄRMEGEDÄMMT



MAßE	MODELL	KBN
DN70	mit Bitumenmanschette	SAG70B
DN70	mit Firestone EPDM-Manschette	SAG70FSEPDM
DN70	mit PVC-Manschette	SAG70PVC
DN100	mit Bitumenmanschette	SAG100B
DN100	mit Firestone EPDM-Manschette	SAG100FSEPDM

## Sita Easy Go Attikagully



MAßE	MODELL	KBN
DN70	mit Bitumenmanschette	SAG70EGB
DN100	mit Bitumenmanschette	SAG100EGB

## Sita Sanierungs-Gully



	MAßE	MODELL	KBN
	100 - 140 mm	mit Bitumenmanschette	SSG95
	140 - 165 mm	mit Bitumenmanschette	SSG125
	165 - 200 mm	mit Bitumenmanschette	SSG165

## Sita Compact Balkongully



	MAßE	MODELL	KBN
	DN70	senkrecht mit Bitumenmanschette	SCBGS70B
	DN70	abgewinkelt mit Flansch	SCFBGA70B

## Sita Mini-Gully



	MAßE	MODELL	KBN
	DN50	abgewinkelt mit Bitumenmanschette	SMDA50B
	DN70	abgewinkelt mit Bitumenmanschette	SMDA70B

## Sita Flansch Dach-Gully



	MAßE	MODELL	KBN
	DN70	abgewinkelt mit Schraubflansch	SFDA70
	DN 100	senkrecht mit Schraubflansch	SFDS100

## Sita Sicherungsschelle



	MAßE	MODELL	KBN
	70/75 mm	Edelstahl	SASS7075
	100/110 mm	Edelstahl	SASS100110

## Kiesfang



## MAßE

75 - 200 mm

## MODELL

Allround

## KBN

SKFALLROUND

## Sita Edelstahlrohr



## MAßE

DN70 x 500 mm

DN70 x 1000 mm

DN100 x 500 mm

DN100 x 1000 mm

## MODELL

für Attika

für Attika

für Attika

für Attika

## KBN

SER70500

SER701000

SER100500

SER1001000

## Sita Edelstahlbogen



## MAßE

DN70

DN100

## MODELL

87,5 Grad

87,5 Grad

## KBN

SEB7088

SEB10088

## Klöber Flachdacheinlauf / Lüfterunterteil



MAßE	MODELL	KBN
DN 70	mit Bitumen-Manschette	KLLU70BI
DN 70	mit Hart-PVC-Anschluss	KL6500
DN 100	mit Bitumen-Manschette	KLLU100BI
DN 100	mit Hart-PVC-Anschluss	KL6510

## Klöber Laubfang für Flachdacheinlauf



MAßE	MODELL	KBN
DN 70	Steckverbindung	KLLF70
DN 100	Steckverbindung	KLLF100

## Be- und Entlüfter Flavent einteilig



MAßE	MODELL	KBN
DN 70	mit Bitumen-Manschette	KLDRBI70
DN 100	mit Bitumen-Manschette	KLDRBI100
DN 100	mit Hart-PVC-Anschluss	KL105

## Flachdachdämmplatte EPS 035 DAA

### MIT FALZ



MAßE	MODELL	KBN
40 x 1000 x 1000 mm	>150 kPa	EPS35F40150
60 x 1000 x 1000 mm	>150 kPa	EPS35F60150
80 x 1000 x 1000 mm	>150 kPa	EPS35F80150
100 x 1000 x 1000 mm	>150 kPa	EPS35F100150
120 x 1000 x 1000 mm	>150 kPa	EPS35F120150
140 x 1000 x 1000 mm	>150 kPa	EPS35F140150
160 x 1000 x 1000 mm	>150 kPa	EPS35F160150

## Gefälleplatte EPS 035 2% Gefälle

### OHNE FALZ



MAßE	MODELL	KBN
20 - 40 mm	>150 kPa   1 x 1 m	EP35G3515024
40 - 60 mm	>150 kPa   1 x 1 m	EP35G3515046
60 - 80 mm	>150 kPa   1 x 1 m	EP35G3515068
80 - 100 mm	>150 kPa   1 x 1 m	EP35G35150810

## Soprema EFYOS BLUE Flachdachdämmplatten

### BEIDSEITIG ALU-KASCHIERT



MAßE	MODELL	KBN
60 x 1200 x 600 mm	WLS 23 mit Stufenfalz	SOPUFD60ALSF
80 x 1200 x 600 mm	WLS 23 mit Stufenfalz	SOPUFD80ALSF
100 x 1200 x 600 mm	WLS 23 mit Stufenfalz	SOPUFD100ALSF
120 x 1200 x 600 mm	WLS 23 mit Stufenfalz	SOPUFD120ALSF

## Dachdämmkeil PUR



MAßE	MODELL	KBN
100 x 100 mm	Länge 1 m	PUK100K
50 x 50 mm	Länge 1,20 m	PUK50K

## Dämmstoffkleber



MAßE	MODELL	KBN
5,5 kg	PU-Dachkleber Soudatherm Roof 170	PUKL5
850 ml	Roof 250	POPUDKL800

## Soprema Ausgleichsschüttung



MAßE	MODELL	KBN
6 kg	SOPRATHERM	SOAGS6

## Dach EPS Keil



MAßE	MODELL	KBN
50 x 50 mm	Länge 1 m	EPSK50
100 x 100 mm	Länge 1 m	EPSK100



## Inhalt

	Seite
Walzblei	D1
Koramic Alegra 10	D2
Poesis Anschlussband	D3
Theis-Böger Schiefer, Faserzementplatten	D5
Flender Laufrost	D6
Flender Schneefangsystem	D7
Klöber Universaldurchführung	D8 – D9
Unterspannbahn, Dampfbremse	D10 – D11
Puren Dämmung	D12
Steico	D13
Stehfalz-Zubehör	D14
Ausstiegsfenster	D15
Velux GGU und GPU	D16
Velux Eindeckrahmen	D17
Velux Montagezubehör	D18
Velux Innenfutter	D19
Velux Rollläden	D20
Velux Austauschprogramm	D21
ROTO Fenster	D22
ROTO Eindeckrahmen	D23
ROTO Rollläden	D23



## Walzblei

## SATURN-BLEI



MAßE	MODELL	KBN
1,25 x 1000 mm	3,50 m / 50 kg	WB12
1,25 x 250 mm	7,02 m / 25 kg	WBST25
1,25 x 330 mm	5,35 m / 25 kg	WBST33
1,25 x 450 mm	3,90 m / 25 kg	WBST45

## BLEIPLUS

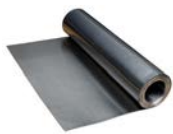

MAßE	MODELL	KBN
1,25 x 1000 mm	3,50 m / 50 kg	WBP12
1,25 x 250 mm	7,00 m x 25 kg	WBSTP25
1,25 x 330 mm	5,30 m / 25 kg	WBSTP33
1,25 x 450 mm	3,90 m / 25 kg	WBSTP45

## VENUSBLEI

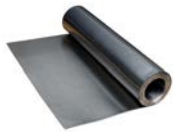

MAßE	MODELL	KBN
1,25 x 1000 mm	3,50 m / 50 kg	VWB12
1,25 x 250 mm	7,055 m x 25 kg	VWBST25
1,25 x 330 mm	5,350 m / 25 kg	VWBST33
1,25 x 450 mm	3,90 m / 25 kg	VWBST45
1,25 x 500 mm	3,50 m / 25 kg	VWBST50



## BLEI-COLOR SELBSTKLEBEND



MAßE	MODELL	KBN
1,5 x 300 mm	Schwarzgrau 5,0 m / 11,9 kg	BCSK30G
1,5 x 300 mm	Ziegelrot 5,0 m / 11,9 kg	BCSK30R
1,5 x 300 mm	braun 5,0 m / 11,9 kg	BCSK30B
1,5 x 300 mm	rotbraun 5,0 m / 11,9 kg	BCSK30RB 

## Antenneneinfassung

## SATURN-BLEI



MAßE	MODELL	KBN
60 mm	2-teilig	WBAE2

## Koramic Alegra 10 Ziegel

### TIEFSCHWARZ ENGOBIERT



MODELL	KBN
Flächenziegel Bedarf: ca. 11 St/m <sup>2</sup>	KOALEGRA10FZSN
Ortgangziegel links Bedarf ca. 2,8 St/m	KOALEGRA10OLS
Ortgangziegel rechts Bedarf ca. 2,8 St/m	KOALEGRA10ORS
Firstziegel Nr. 15 Bedarf ca.2,5St/m	KOFIRST15S
First Anfangsziegel Nr. 15	KOFIRST15AS
First Nr. 15 Gratanfänger	KOFIRST15GAS
Antenensystem Ton	KOALEGRA10AZS
Dunstrohrsystem	KOALEGRA10DRS
Schraubensystem für First Nr. 15	KOALEGRA15SS
Sturmklammern f. 40 x60 Latten	SKL4528ZI
Firstziegel Nr.20 konisch	KOFIRST20S
First-Anfangsziegel Nr. 20	KOFIRST20AS
First-Endziegel Nr. 20	KOFIRST20ESCH

## Koramic Alegra 10 Ziegel

### EDELSCHWARZ



MODELL	KBN
Flächenziegel Bedarf: ca. 11 St/m <sup>2</sup>	KOALEGRA10FZES
Ortgangziegel links Bedarf ca. 2,8 St/m	KOALEGRA10OLES
Ortgangziegel rechts Bedarf ca. 2,8 St/m	KOALEGRA10ORES
Firstziegel Nr. 15 Bedarf ca.2,5St/m	KOFIRST15ESN

## Wand- / Kaminanschluß

Koraflex Plus			
	MAßE	MODELL	KBN
	300 mm x 5 m	schwarz	KOKORAFLEXP5W
	300 mm x 5 m	rot	KOKORAFLEXPRT

## poesis annex Kehldichtungstreifen

SCHWARZ			
	MAßE	MODELL	KBN
	30 x 75 x 1000 mm		POANKDS7530SW

## poesis annex Traufenlüftungskamm

SCHWARZ			
	MAßE	MODELL	KBN
	55 mm x 1 m	schwarz	POANTLK55SW
	1 m	schwarz mit Belüftung	POANTEK4SW

## poesis tego First- und Gratrolle

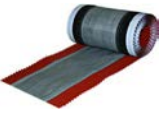
TEGO			
	MAßE	MODELL	KBN
	310 mm x 5 m	rot	POTEGO310RT
	310 mm x 5 m	schwarz	POTEGO310SW
	390 mm x 5 m	rot	POTEGO390RT
	390 mm x 5 m	schwarz	POTEGO390SW

## poesis tego K Universal Anschlussband

TEGO K			
	MAßE	MODELL	KBN
	300 mm x 5 m	schwarz	POTEGOK300SW

## poesis tego TEC Wand- / Kaminanschluß

TEGO TEC			
	MAßE	MODELL	KBN
	300 mm x 5 m	rot	POTEGOTEC300RO

**poesis annex Lüftungsgitter**

MAßE	MODELL	KBN
100 mm x 60 m	PVC schwarz	POANLG6100SW
100 mm x 60 m	Alu blank	POANLGALU100
100 mm x 60 m	Alu rot/schwarz	POANLGALU100RS
30/90 mm x 2,5 m	PVC schwarz Winkel	POANLGP3090

## Theis-Böger Naturschiefer

### Universal A1



MAßE	MODELL	KBN
20 x 20 cm	Standard gelocht, gebündelt	NSCHI2020SUTB
25 x 25 cm	Standard gelocht, gebündelt	NSCHI2525SUTB
30 x 30 cm	Standard gelocht, gebündelt	NSCHI3030SUTB

### Rechtecker A1



MAßE	MODELL	KBN
30 x 20 cm	ungelocht	NSCHI3020STB
40 x 20 cm	ungelocht	NSCHI4020STB
60 x 30 cm	ungelocht	NSCHI6030TB

## Schieferstifte

### VERZINKT

MAßE	MODELL	KBN
2,8 x 35 mm	k. A.	VSCHS2835
2,8 x 50 mm	k. A.	VSCHS2850
4,8 x 35 mm	Haltefest	VSCHS4835H
4,8 x 45 mm	Haltefest	VSCHS4845H
4,8 x 50 mm	Haltefest	VSCHS4850H

## Laufrost Flender

	MAßE	MODELL	KBN
	250 x 600 mm	verzinkt	VLR600
	250 x 800 mm	verzinkt	VLR800
	250 x 1000 mm	verzinkt	VLR1000
	250 x 1500 mm	verzinkt	VLR1500
	250 x 2000 mm	verzinkt	VLR2000
			Befestigungsmaterial Edelstahl
		Verbindungsmaterial f. Laufrost verzinkt	VVMLR

## Laufrost Komplettelement verzinkt Flender

VERZINKT			
	MAßE	MODELL	KBN
	250 x 800 mm	Inkl. 2 Laufroststützen, 1 Laufrost, 1x Befestigung VA zum Enhängen auf Ziegel	VLRKE7B80

## Laufroststütze verzinkt Flender

VERZINKT			
	MAßE	MODELL	KBN
		7B / Ziegel zum Einhängen	VLRS7B
		1 / gerade für Schiefer und Blechdach	VLRS1

## Sicherheitsdachhaken Flender

VERZINKT			
	MAßE	MODELL	KBN
	30 x 6 mm	3 SF f. Schiefer inkl. Nägel Länge 360 mm	VSD3SF306



## Schneefang-System Flender

VERZINKT			
	MAßE	MODELL	KBN
	13 x 200 mm	Schneefanggitter 13 x 13 x 2 mm	VSG1313220
	13 x 13 mm	Schneefangmuffe	VSM1313VA
	200 x 460 mm	Schneefangstütze Nr. 59 200 mm hoch HW42 mm für Dachziegel zum Einhängen	VS2059
	200 x 30 x 6 mm	Schneefangstütze Nr. 60 200 mm hoch HW42 mm gerade für Biber und Blechdach zum Aufnageln	VS2030660G
	200 x 25 x 6 mm	Schneefangstütze Nr. 61 200 mm hoch HW 42 mm für Dachziegel und -steine zum Einhängen	VS2025661G42HW

## Schneefangrohr und Zubehör

ALUMINIUM / PVC			
	MAßE	MODELL	KBN
	32 x 2 mm	Schneefangrohr 6 m Aluminium	AR33
		Schneefangglaschen Alu m. V2A-Schrauben	ASCHNEE
		Schnee- u. Eishalter Alu inkl. 2 Edelstahlschrauben	AEIS
		Rohrverbinder PVC für Schneefangrohr	PVCRVB
	32 mm	Endkappe PVC für Schneefangrohr grau	PVCEK

## Klöber Universaldachdurchführung

	MAßE	MODELL	KBN
	DN100	Rovia rot	KLKE520R
	DN100	Rovia anthrazit	KLKE520A
	DN100	Rovia schwarz	KLKE520SW

## Dachdurchführungsmanschette EPDM

	MAßE	MODELL	KBN
	75 - 175 mm	schwarz mit Schrauben und Silikon	PODMS22

## Klöber Grundplatte

	MAßE	MODELL	KBN
		Frankf. Pfanne KE 0001 rot	KLKE1RT
		Frankf. Pfanne KE 0001 schwarz	KLKE1SW
	40 x 40 cm	KE 40/40-oR schwarz Schiefer	KLKE40ORSW

## Klöber Hochleistungslüfter Venduct

	MAßE	MODELL	KBN
	DN100	rot	KLELVRT100
	DN100	schwarz	KLELVSW100



## Klöber Belüfterrohr Fluenta

	MAßE	MODELL	KBN
	DN100	rot	KLKE8015RT
	DN100	schwarz	KLKE8015SW

## Anschlussschlauch PVC

	MAßE	MODELL	KBN
	DN125 x 700 mm	Klöber rot 70/100/125 mm	KLKE8058
	DN 50/70/100 110 mm	Dunstrohranschluss flexibel schwarz	DRF
		Uni-Flex-Stutzen weiß	UNIFST
	DN 110 x 650 mm	Klöber Anschlussschlauch orange Adapter 75 / 90 / 100	KLKE8040N
	DN 110/ 125 x 650 mm	poesis annex grau für Anschlüsse 75/90/100	POFLEX

## Klöber Solaraufsatz für Grundpfannen

	MAßE	MODELL	KBN
	DN 100	KE 8080 anthrazit	KLKE8080A
	DN 100	KE 8080 rot	KLKE8080RT

## Solar-Rohrdurchgang

	MODELL	KBN
	Typ Beton braun	MASDBTBR
	Typ Beton rot	MASDBTRT
	Typ Ton braun	MASDTONBR
	Typ Ton rot	MASDTONRT
	Typ NE Titanzink	MASDTONTZ

## Lehmann PB-Aufdach Modulhalter

	MODELL	KBN
	RUBIN9V anthrazit	PAMRUBIN9VAZ
	Taunuspfanne anthrazit	PAMTAUNUSAZ
	NP Frankfurter Pfanne anthrazit	PAMFRANKAZ
	NP Frankfurter Pfanne ziegelrot	PAMFRANKZ

## Poesis TAVUS Unterspann- /Unterdeckbahn

### MIT DOPPELKLEBESTREIFEN

**MAßE**

1,50 x 50 m

**MODELL**

150 g/qm dreilagig hochdiffusionsoffen

**KBN**

TAVUS150SK

## Klöber Unterdeckbahn Permo easy SK

### MIT DOPPELKLEBESTREIFEN

**MAßE**

1,50 x 50 m

**MODELL**

145 g/qm, diffusionsoffen

**KBN**

KLPEBK145

## Pro Clima Unterspannbahn Solitex Mento

### MIT 2 INTEGRIERTEN SELBSTKLEBEZONEN

**MAßE**

1,50 x 50 m

**MODELL**

3000 connect 3-lagig

**KBN**

MENTO300015C

## Dampfbremse Pro Clima Intello Plus

### WEIß / TRANSPARENT

**MAßE**

1,50 x 50 m

**MODELL**

feuchtevariabel

**KBN**

INTELLOP15

## Dampfbremse PE 250my

### BLAU EINGEFÄRBT

**MAßE**

4,0 x 25 m

**MODELL**

Klasse nach DIN 13987

**KBN**

DSPE25425

## ProClima Tescon Vana

	MAßE	MODELL	KBN
	0,10 x 30 m	Klebeband f. Innen und Außen	TESVANA100
	0,15 x 30 m	Klebeband f. Innen und Außen	TESVANA150
	0,15 x 30 m	Klebeband f. Innen und Außen	TESVANA200
	0,60 x 30 m	Allround-Klebeband	TESVANA60N

## ProClima Beo Allround-Kleber

	MAßE	MODELL	KBN
	310 ml	Orcon F Kartusche	ORCONF310

## ProClima Tescon Primer

	MAßE	MODELL	KBN
	750 ml	SPrimer sprühbare Grundierung	SPRIMER750
	1000 ml	RP Primer, Reichweite f. ca. 10 m <sup>2</sup>	TESCONRP1

## ProClima Orcon Multiband

	MAßE	MODELL	KBN
	2 Rollen á 10 m	für Innen und Außen	ORCONMULTINP

## Zellulosedämmstoff Poesis-Floc-bt

	MAßE	MODELL	KBN
	12,5 kg	0,040 W/(m*K) Z-23.11-1236	POFLOCBT

## Puren Plus Dämmplatte WLS 026

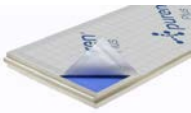
MIT NUT UND FEDER			
	MAßE	MODELL	KBN
	120 mm	2380 x 1000 mm, diffusionsoffen	PPLUS120
	140 mm	2380 x 1000 mm, diffusionsoffen	PPLUS140
	160 mm	2380 x 1000 mm, diffusionsoffen	PPLUS160
	180 mm	2380 x 1000 mm, diffusionsoffen	PPLUS180

## Puren DB blau Schalungsbahn

	MAßE	MODELL	KBN
	1500 mm x 50 m	Sd>3 m Konvektionssperre	PDBBL

## Puren Diffucell First- /Gratband

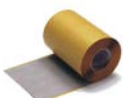
	MAßE	MODELL	KBN
	3000 mm x 50 m	1-seitig selbstklebend	PDIFFUCELL

## Puren Perfect Dämmplatte WLS

MIT NUT UND FEDER			
	MAßE	MODELL	KBN
	160 mm	2380 x 1000 mm	PPERFECT160

## Puren Top DBS

MIT NUT UND FEDER			
	MAßE	MODELL	KBN
	50 x 1,5 mm	Vordeckbahn Sd> 100 m	PTOPDSB

## Steico flex 036

### HOLZFASERDÄMMSTOFF



MAßE	MODELL	KBN
40 x 1220 x 575 mm	flexibel	STFLEX03640
60 x 1220 x 575 mm	flexibel	STFLEX03660
80 x 1220 x 575 mm	flexibel	STFLEX03680
100 x 1220 x 575 mm	flexibel	STFLEX036100
120 x 1220 x 575 mm	flexibel	STFLEX036120

## Steico universal dry

### UNTERDECK- UND WANDBAUPLATTE



MAßE	MODELL	KBN
35 x 2500 x 600 mm	mit Nut und Feder	STUNIDRY35N
60 x 1880 x 600 mm	mit Nut und Feder	STUNIDRY60
80 x 1880 x 600 mm	mit Nut und Feder	STUNIDRY80
100 x 1880 x 600 mm	mit Nut und Feder	STUNIDRY100

## Steico protect H

### HOLZFASERDÄMMPLATTE



MAßE	MODELL	KBN
60 x 1325 x 600 mm	mit Nut und Feder	STPROTH60NF

## Steico multi



MAßE	MODELL	KBN
1500 mm	UDB Luftdichtungsbahn renova Dampfbremse	STMULTIUBB STMULTIRENOVA

## Trennlage Klöber

### PERMO SEC SK

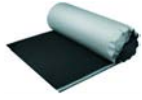

#### MAßE

1,50 x 25 m

#### MODELL

für Stehfalzdächer m. Butylklebestreifen

#### KBN

KLKU00271

### GRID SEC



#### MAßE

1,40 x 25 m

#### MODELL

für Stehfalzdächer

#### KBN

KLKU0028

## Rheinzink Dichtungsband für Stehfalzdeckungen

#### MAßE

18 m

#### MODELL

für Stehfalzdächer

#### KBN

ILLMODX



## Rheinzink Festpunkthaft

### EDELSTAHL



#### MAßE

30 x 25 mm  
28 mm

#### MODELL

Nr.5 für Winkel u. Maschinenfalz  
für Scharbefestigung mit strukt. Trennlage

#### KBN

EFHM  
EFHMH

## Rheinzink Schiebehafte

### EDELSTAHL



#### MAßE

90 x 25 mm  
28 mm

#### MODELL

Nr.6 für Winkel u. Maschinenfalz  
für Scharbefestigung mit strukt. Trennlage

#### KBN

ESHM  
ESHMH

## Rheinzink Trennlage

### FÜR STEHFALZDÄCHER

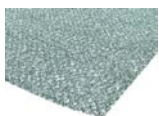

#### MAßE

75 x 1,0 m  
30 x 1,5 m

#### MODELL

AIR-Z  
VAPOZINC

#### KBN

AIRZ751  
VAPOZINC3015

## Lehmann Dachfenster

VERZINKT			
	MAßE	MODELL	KBN
	420 x 520 mm	für Falz-und Pfannenziegel seitlich öffnend	VDFEPFANNES

## Velux Ausstiegsfenster

GVK ISOLIERVERGLAST			
	MAßE	MODELL	KBN
	460 x 610 mm	schwarz GVK 0000Z für Kalträume	VX046061GVK

GVT WÄRMEGEDÄMMT			
	MAßE	MODELL	KBN
	540 x 830 mm	schwarz GVT 103 0059Z für Kalträume	VX054083GVT

## Velux Wohn- und Ausstiegsfenster

GXU			
	MAßE	MODELL	KBN
	550 x 980 mm	THERMO Alu GXU CK04 0070 Polyur.	VXGXUCK040070
	550 x 1180 mm	THERMO Alu GXU CK06 0070 Polyur.	VXGXUCK060070
	550 x 980 mm	ENERGIE PLUS Alu GXU CK04 0066	VXGXUCK040066
	550 x 1180 mm	ENERGIE PLUS Alu GXU CK06 0066	VXGXUCK060066

GTU			
	MAßE	MODELL	KBN
	780 x 1400 mm	THERMO Alu GXU MK08 0070 Polyur.	VXGTUMK080070
	1140 x 1400 mm	THERMO Alu GXU SK08 0070 Polyur.	VXGTUSK080070

# VELUX®

## Velux GGU Schwingfenster Kunststoff

GGU	MAßE	MODELL	KBN
	550 x 780 mm	GGU CK02 0070 THERMO	VXGGUCK020070
	550 x 980 mm	GGU CK04 0066 ENERGIE PLUS	VXGGUCK040066
	550 x 980 mm	GGU CK04 0070 THERMO	VXGGUCK040070
	550 x 1180 mm	GGU CK06 0070 THERMO	VXGGUCK060070
	660 x 980 mm	GGU FK04 0070 THERMO	VXGGUFK040070
	660 x 1180 mm	GGU FK06 0070 THERMO	VXGGUFK060070
	780 x 980 mm	GGU MK04 0070 THERMO	VXGGUMK040070
	780 x 1180 mm	GGU MK06 0070 THERMO	VXGGUMK060070
	780 x 1400 mm	GGU MK08 0070 THERMO	VXGGUMK080070
	940 x 1180 mm	GGU PK06 0070 THERMO	VXGGUPK060070
	940 x 1400 mm	GGU PK08 0070 THERMO	VXGGUPK080070
	1140 x 1180 mm	GGU SK06 0070 THERMO	VXGGUSK060070
	1140 x 1400 mm	GGU SK08 0070 THERMO	VXGGUSK080070

## Velux GPU Klapp-Schwingfenster Kunststoff

GPU	MAßE	MODELL	KBN
	550 x 980 mm	GPU CK04 0070 THERMO	VXGPUCK040070
	550 x 1180 mm	GPU CK06 0070 THERMO	VXGPUCK060070
	660 x 1180 mm	GPU FK06 0070 THERMO	VXGPUFK060070
	780 x 980 mm	GPU MK04 0070 THERMO	VXGPUMK040070
	780 x 1180 mm	GPU MK06 0070 THERMO	VXGPUMK060070
	780 x 1400 mm	GPU MK08 0070 THERMO	VXGPUMK080070
	940 x 1180 mm	GPU PK06 0070 THERMO	VXGPUPK060070
	940 x 1180 mm	GPU PK06 0066 ENERGIE PLUS	VXGPUPK060066
	940 x 1180 mm	GPU PK06 0068 ENERGIE	VXGPUPK060068
	940 x 1400 mm	GPU PK08 0070 THERMO	VXGPUPK080070
	940 x 1400 mm	GPU PK08 0068 ENERGIE	VXGPUPK080068
	940 x 1600 mm	GPU PK10 0070 THERMO	VXGPUPK100070
	1140 x 1180 mm	GPU SK06 0070 THERMO	VXGPUSK060070
	1140 x 1180 mm	GPU SK06 0066 ENERGIE PLUS	VXGPUSK060066
	1140 x 1180 mm	GPU SK06 0068 ENERGIE	VXGPUSK060068
	1140 x 1400 mm	GPU SK08 0070 THERMO	VXGPUSK080070
	1140 x 1400 mm	GPU SK08 0066 ENERGIE PLUS	VXGPUSK080066
	1140 x 1400 mm	GPU SK08 0068 ENERGIE	VXGPUSK080068
	1140 x 1600 mm	GPU SK10 0070 THERMO	VXGPUSK100070
	1140 x 1600 mm	GPU SK10 0066 ENERGIE PLUS	VXGPUSK100066
	1340 x 1400 mm	GPU UK08 0070 THERMO	VXGPUUK080070



## Velux EDZ Eindeckrahmen

ZIEGEL			
	MAßE	MODELL	KBN
	550 x 780 mm	EDZ CK02 1000 inklusive BDX	VXEDZCK021000
	550 x 780 mm	EDZ CK02 2000 inklusive BDX	VXEDZCK022000
	550 x 980 mm	EDZ CK04 1000 inklusive BDX	VXEDZCK041000
	550 x 980 mm	EDZ CK04 2000 inklusive BDX	VXEDZCK042000
	550 x 1180 mm	EDZ CK06 1000 inklusive BDX	VXEDZCK061000
	550 x 1180 mm	EDZ CK06 2000 inklusive BDX	VXEDZCK062000
	660 x 980 mm	EDZ FK04 2000 inklusive BDX	VXEDZFK042000
	660 x 1180 mm	EDZ FK06 0000	VXEDZFK060000
	660 x 1180 mm	EDZ FK06 2000 inklusive BDX	VXEDZFK062000
	780 x 980 mm	EDZ MK04 2000 inklusive BDX	VXEDZMK042000
	780 x 1180 mm	EDZ MK06 1000 inklusive BDX	VXEDZMK061000
	780 x 1180 mm	EDZ MK06 2000 inklusive BDX	VXEDZMK062000
	780 x 1400 mm	EDZ MK08 2000 inklusive BDX	VXEDZMK082000
	780 x 1600 mm	EDZ MK10 2000 inklusive BDX	VXEDZMK102000
	940 x 1180 mm	EDZ PK06 0000	VXEDZPK060000
	940 x 1180 mm	EDZ PK06 2000 inklusive BDX	VXEDZPK062000
	940 x 1400 mm	EDZ PK08 2000 inklusive BDX	VXEDZPK082000
	940 x 1600 mm	EDZ PK10 2000 inklusive BDX	VXEDZPK102000
	1140 x 1180 mm	EDZ SK06 0000	VXEDZSK060000
1140 x 1180 mm	EDZ SK06 2000 inklusive BDX	VXEDZSK062000	
1140 x 1400 mm	EDZ SK08 2000 inklusive BDX	VXEDZSK082000	
1140 x 1600 mm	EDZ SK10 2000 inklusive BDX	VXEDZSK102000	
1340 x 1400 mm	EDZ UK08 0000	VXEDZUK080000	
1340 x 1400 mm	EDZ UK08 2000 inklusive BDX	VXEDZUK082000	

## Velux EDS Eindeckrahmen

SCHIEFER STEHFALZ			
	MAßE	MODELL	KBN
	550 x 780 mm	EDS CK02 2000 inklusive BDX	VXEDSCK022000
	550 x 980 mm	EDS CK04 2000 inklusive BDX	VXEDSCK042000
	780 x 1400 mm	EDS MK08 2000 inklusive BDX	VXEDSMK082000
	940 x 1180 mm	EDS PK06 2000 inklusive BDX	VXEDSPK062000
	940 x 1400 mm	EDS PK08 2000 inklusive BDX	VXEDSPK082000
	1140 x 1180 mm	EDS SK06 2000 inklusive BDX	VXEDSSK062000
	1140 x 1400 mm	EDS SK08 2000 inklusive BDX	VXEDSSK082000

## Velux ETW Eindeckrahmen-Verlängerungsteile

	MODELL	KBN
	ETW WK34 0000	VXETW

## Velux BBX Dampfsperrschürze

	MAßE	MODELL	KBN
	550 x 780 mm	BBX CK02 0000	VX055078BBX
	550 x 980 mm	BBX CK04 0000	VX055098BBX
	550 x 1180 mm	BBX CK06 0000	VX055118BBX
	660 x 1180 mm	BBX FK06 0000	VX066118BBX
	780 x 1180 mm	BBX MK06 0000	VX078118BBX
	780 x 1400 mm	BBX MK08 0000	VX078140BBX
	940 x 1180 mm	BBX PK06 0000	VX094118BBX
	940 x 1400 mm	BBX PK08 0000	VX094140BBX
	1140 x 1180 mm	BBX SK06 0000	VX114118BBX
	1140 x 1400 mm	BBX SK08 0000	VX114140BBX

## Velux Dämm- und Montagerahmen

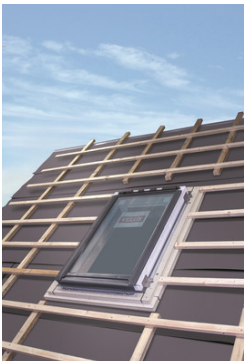
INKLUSIVE BUTYKLEBER			
	MAßE	MODELL	KBN
	550 x 980 mm	BGX CK04 0000	VXD MR5598BK
	550 x 1180 mm	BGX CK06 0000	VXD MR55118BK
	780 x 1180 mm	BGX MK06 0000	VXD MR78118BK
	940 x 1180 mm	BGX PK06 0000	VXD MR94118BK
	940 x 1400 mm	BGX PK08 0000	VXD MR94140BK
	1140 x 1180 mm	BGX SK06 0000	VXD MR114118BK
	1140 x 1400 mm	BGX SK08 0000	VXD MR114140BK

## Velux LSB Innenfutter Grundelement 30 cm

WEIß



MAßE	MODELL	KBN
550 x 780 mm	LSB CK02 2000	VXLSBCK022000
550 x 980 mm	LSB CK04 2000	VXLSBCK042000
550 x 1180 mm	LSB CK06 2000	VXLSBCK062000
660 x 1180 mm	LSB FK06 2000	VXLSBFK062000
780 x 1180 mm	LSB MK06 2000	VXLSBMK062000
780 x 1400 mm	LSB MK08 2000	VXLSBMK082000
940 x 1180 mm	LSB PK06 2000	VXLSBPK062000
940 x 1400 mm	LSB PK08 2000	VXLSBPK082000
1140 x 1180 mm	LSB SK06 2000	VXLSBSK062000
1140 x 1400 mm	LSB SK08 2000	VXLSBSK082000

## Velux SSL Solar-Rollladen

### DUNKELGRAU



MAßE	MODELL	KBN
550 x 780 mm	SSL CK02 0000S	VX055078SSL
550 x 980 mm	SSL CK04 0000S	VX055098SSL
550 x 1180 mm	SSL CK06 0000S	VX055118SSL
660 x 1180 mm	SSL FK06 0000S	VX066118SSL
780 x 980 mm	SSL MK04 0000S	VX078098SSL
780 x 1180 mm	SSL MK06 0000S	VX078118SSL
780 x 1400 mm	SSL MK08 0000S	VX078140SSL
940 x 1180 mm	SSL PK06 0000S	VX094118SSL
940 x 1400 mm	SSL PK08 0000S	VX094140SSL
940 x 1600 mm	SSL PK10 0000S	VX094160SSL
1140 x 1180 mm	SSL SK06 0000S	VX114118SSL
1140 x 1400 mm	SSL SK08 0000S	VX114140SSL
1140 x 1600 mm	SSL SK10 0000S	VX114160SSL
1340 x 1400 mm	SSL UK08 0000S	VX134140SSL

## Velux SML Elektro-Rollladen



MAßE	MODELL	KBN
780 x 1180 mm	SML MK06 0000S dunkelgrau	VX078118SML
780 x 1400 mm	SML MK08 0000S dunkelgrau	VX078140SML
940 x 1180 mm	SML PK06 0000S dunkelgrau	VX094118SML
940 x 1400 mm	SML PK06 0000S dunkelgrau	VX094140SML
1140 x 1180 mm	SML SK06 0000S dunkelgrau	VX114118SML
1140 x 1400 mm	SML SK06 0000S dunkelgrau	VX114140SML

## Velux Zubehör



MAßE	MODELL	KBN
800 mm	KUX110 Steuersystem	VXKUX110
1080 - 1880 mm	ZCZ 80 Bedienstange	VXZCZ080
	ZCT 200 Teleskop-Bedienungsstange	VXZCT200

## Velux VKU Klapp-Schwing-Austauschfenster

KUNSTSTOFF			
	MAßE	MODELL	KBN
	750 x 1040 mm	VKU Y43 0081 THERMO	VXVKUY430081
	750 x 1240 mm	VKU Y45 0081 THERMO	VXVKUY450081
	1130 x 1240 mm	VKU Y85 0081 THERMO	VXVKUY850081

## Velux VU Schwing-Austauschfenster

KUNSTSTOFF			
	MAßE	MODELL	KBN
	550 x 840 mm	VU Y21 0074 THERMO	VXVUY210074
	550 x 1040 mm	VU Y23 0081 THERMO	VXVUY230081
	750 x 1040 mm	VU Y43 0081 THERMO	VXVUY430081
	1130 x 1240 mm	VU Y85 0081 THERMO	VXVUY850081

## Velux EZ Eindeckrahmen

ZIEGEL			
	MAßE	MODELL	KBN
	550 x 840 mm	EZ Y21 1000 inkl. Anschlussschürze	VXEZY211000
	550 x 1040 mm	EZ Y23 1000 inkl. Anschlussschürze	VXEZY231000
	750 x 1040 mm	EZ Y43 1000 inkl. Anschlussschürze	VXEZY431000
	750 x 1240 mm	EZ Y45 1000 inkl. Anschlussschürze	VXEZY451000
	1130 x 1240 mm	EZ Y85 1000 inkl. Anschlussschürze	VXEZY851000
	1130 x 1440 mm	EZ Y87 1000 inkl. Anschlussschürze	VXEZY871000

## ROTO Designo Klappschwingfenster Kunststoff

R8	MAßE	MODELL	KBN
	540 x 780 mm	R88C 054/078 K200 Comfort	RDWDFR88CKA57
	540 x 980 mm	R88C 054/098 K200 Comfort	RDWDFR88CKA59
	540 x 1180 mm	R88C 054/118 K200 Comfort	RR88C54118K20
	650 x 1180 mm	R88C 065/118 K200 Comfort	RDWDFR88CKA611
	740 x 980 mm	R88C 074/098 K200 Comfort	RDWDFR88CKA79
	740 x 1180 mm	R88C 074/118 K200 Comfort	RDWDFR88CKA711
	740 x 1400 mm	R88C 074/140 K200 Comfort	RDWDFR88CKA714
	940 x 1180 mm	R88C 094/118 K200 Comfort	RDWDFR88CKA911
	940 x 1400 mm	R88C 094/140 K200 Comfort	RDWDFR88CKA914
	1140 x 1180 mm	R88C 114/118 K200 Comfort	RDWDFR88CKA111
	1140 x 1400 mm	R88C 114/140 K200 Comfort	RDWDFR88CKA114
	1140 x 1600 mm	R88C 114/160 K200 Comfort	RDWDFR88CKA116

## ROTOQ Schwingfenster Kunststoff

P5	MAßE	MODELL	KBN
	550 x 780 mm	Q42C 055/078 K200 Comfort	RQ4K2CA5578
	550 x 980 mm	Q42C 055/098 K200 Comfort	RQ4K2CA5598
	940 x 1180 mm	Q42C 094/118 K200 Comfort	RQ4K2CA94118
	940 x 1400 mm	Q42C 094/140 K200 Comfort	RQ4K2CA94140
	1140 x 1180 mm	Q42C 114/118 K200 Comfort	RQ4K2CA114118
	1140 x 1400 mm	Q42C 114/140 K200 Comfort	RQ4K2CA114140

## ROTO Wohndachausstieg Kunststoff

R2	MAßE	MODELL	KBN
	550 x 880 mm	R25 055/080K1DA Standard	RWDAR25KA5588

## ROTO Dachausstieg Kunststoff

R38	MAßE	MODELL	KBN
	054/098	R38 054/098 K2DR rechts	RDWDAR38KA59R
	054/098	R38 054/098 K2DLlinks	RDWDAR38KA59L

## ROTO Designo Eindeckrahmen Ziegel

### ALUMINIUM



MAßE	MODELL	KBN
540 x 780 mm	EDZ 054/078 RX200	RDEDRRXZIEA57
540 x 980 mm	EDZ 054/098 RX200	RDEDRRXZIEA59
540 x 1180 mm	EDZ 054/118 RX200	REDZ054118RX20
650 x 1180 mm	EDZ 065/118 RX200	RDEDRRXZIEA611
740 x 980 mm	EDZ 074/098 RX200	RDEDRRXZIEA79
740 x 1180 mm	EDZ 094/118 RX200	RDEDRRXZIEA711
740 x 1400 mm	EDZ 074/140 RX200	RDEDRRXZIEA714
940 x 1180 mm	EDZ 094/118 RX200	RDEDRRXZIEA911
940 x 1400 mm	EDZ 094/140 RX200	RDEDRRXZIEA914
1140 x 1180 mm	EDZ 114/118 RX200	RDEDRRXZIEA111
1140 x 1400 mm	EDZ 114/160 RX200	RDEDRRXZIEA114
1140 x 1600 mm	EDZ 114/160 RX200	RDEDRRXZIEA116

## ROTO Designo Solar Rollladen

### ANTHRAZIT



MAßE	MODELL	KBN
540 x 780 mm	ZRO S 054/078 R6R8	RZROS54078R6R8
540 x 980 mm	ZRO S 054/098 R6R8	RZROS54098R6R8
540 x 1180 mm	ZRO S 054/118 R6R8	RZROS54118R6R8
650 x 1180 mm	ZRO S 065/118 R6R8	RDZROR6R8611SF
740 x 980 mm	ZRO S 074/098 R6R8	RZROS74098R6R8
940 x 1180 mm	ZRO S 094/118 R6R8	RDZROR6R8911SF
940 x 1400 mm	ZRO S 094/140 R6R8	RDZROR6R8914SF
1140 x 1180 mm	ZRO S 114/118 R6R8	RDZROR6R8111SF
1140 x 1400 mm	ZRO S 114/140 R6R8	RDZROR6R8114SF
1140 x 1600 mm	ZRO S 114/160 R6R8	RDZROR6R8116SF

## ROTO Designo Elektro Rollladen

### ANTHRAZIT



MAßE	MODELL	KBN
740 x 1180 mm	ZRO E 074/118 R6R8	RZROE74118R6R8
740 x 1400 mm	ZRO E 074/140 R6R8	RZROE74140R6R8
940 x 1180 mm	ZRO E 094/118 R6R8	RDZROR6R8911E
940 x 1400 mm	ZRO E 094/140 R6R8	RDZROR6R8914E
1140 x 1180 mm	ZRO E 114/118 R6R8	RDZROR6R81111E
1140 x 1400 mm	ZRO E 114/140 R6R8	RDZROR6R81114E

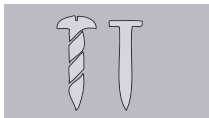

## Inhalt

	Seite
Stockschrauben	E1
Allzweckdübel	E1
Spenglerschrauben	E2
Nieten und Stifte	E3
Heco Senkkopfschrauben	E4
Spachtel- und Klebmasse	E5-E6
Lötwasser	E7
Zinn	E7
Stehfalz-Zubehör	E8
Bautenschutzmatte	E8
TECGET-Sat	E8
Übergänge/Vlies	E8
Grün Brenner Zugehör	E9



## Stockschrauben

## VERZINKT



MAßE	MODELL	KBN
M10 x 100 mm	verzinkt VPE 50	CCLSTS10100
M10 x 120 mm	verzinkt VPE 50	CCLSTS10120
M10 x 140 mm	verzinkt VPE 25	CCLSTS10140
M10 x 180 mm	verzinkt VPE 25	CCLSTS10180
M10 x 200 mm	verzinkt	STS10200
M10 x 250 mm	verzinkt	STS10250
M10 x 300 mm	verzinkt	STS10300
M10	Rosette m. Neopren-Dichtung	ROSETTEM10LH

## Allzweckdübel

## CONEL CLIC



MAßE	MODELL	KBN
6 x 36 mm	FIX-I	CCLFIXI636
6 x 51 mm	FIX-I	CCLFIXI651
8 x 51 mm	FIX-I	CCLFIXI851
10 x 61 mm	FIX-I	CCLFIXI1061
12 x 71 mm	FIX-I	CCLFIXI1271
14 x 75 mm	FIX-I	CCLFIXI1475

## poesis insulo Dämmstoffdübel

## EDELSTAHL



MAßE	MODELL	KBN
M10 x 100 mm	5er-Set V2A	POINDSD

## Fasadenadapter

## VERZINKT



MAßE	MODELL	KBN
M10	verzinkt	VFAM10

## Spenglerschrauben TX 20 Edelstahl

EDELSTAHL			
	MAßE	MODELL	KBN
	4,5 x 25 mm	mit Dichtscheibe 15 mm	SPENG452515
	4,5 x 35 mm	mit Dichtscheibe 15 mm	SPENG453515
	4,5 x 40 mm	mit Dichtscheibe 15 mm	SPENG454015
	4,5 x 45 mm	mit Dichtscheibe 15 mm	SPENG454515
	4,5 x 70 mm	mit Dichtscheibe 15 mm	SPENG457015
	4,5 x 70 mm	mit Dichtscheibe 20 mm	SPENG457020
	4,5 x 35 mm	mit Dichtscheibe 20 mm	SPENG453520
	4,5 x 45 mm	mit Dichtscheibe 20 mm	SPENG454520
	4,5 x 60 mm	mit Dichtscheibe 20 mm	SPENG456020
	4,5 x 65 mm	mit Dichtscheibe 20 mm	SPENG456520

KUPFER			
	MAßE	MODELL	KBN
	4,5 x 25 mm	mit Dichtscheibe 15 mm	SPENGCU452515
	4,5 x 35 mm	mit Dichtscheibe 15 mm	SPENGCU453515
	4,5 x 35 mm	mit Dichtscheibe 20 mm	SPENGCU453520
	4,5 x 45 mm	mit Dichtscheibe 20 mm	SPENGCU454520

## Befestigungsteller

EDELSTAHL		
	MODELL	KBN
	Befestigungsteller Stahl HTV-82/40 TK	HTV8240TK

## Schraubenkappe

ZINK			
	MAßE	MODELL	KBN
	35 mm	Zink	TSKA35N

## Dichtblindnieten

	MAßE	MODELL	KBN
	3,2 x 6,5 mm	Alu m. Stahlstift luft-und wasserdicht	ADBN3265
	3,0 x 5,0 mm	Alu m. Stahlstift und Flachrundkopf	ABN35
	4,0 x 10,0 mm	Alu m. Stahlstift und Flachrundkopf	ABN410
	3,0 x 5,0 mm	Kupfer m. Bronzestift u. Flachrundkopf	NIETCU35
	3,2 x 6,5 mm	Kupfer m. Edelstahlstift luft-und wasserdicht	NIETDICHT3265

## Stifte

## RINNEHALTERSTIFTE

	MAßE	MODELL	KBN
	4,2 x 65 mm	verzinkt	VRHS4265
	4,2 x 80 mm	verzinkt	VRHS4280
	4,2 x 65 mm	Kupfer	KRHS4265

## SCHIEFERSTIFTE VERZINKT

	MAßE	MODELL	KBN
	2,8 x 35 mm	k.A.	VSCHS2835
	2,8 x 50 mm	k.A.	VSCHS2850
	4,8 x 35 mm	Haltefest	VSCHS4835H
	4,8 x 45 mm	Haltefest	VSCHS4845H
	4,8 x 50 mm	Haltefest	VSCHS4850H

## DACHPAPPSTIFTE

	MAßE	MODELL	KBN
	2,8 x 25 mm	Kupfer rund m. gerauhtem Schaft	KDPS2825
	2,8 x 25 mm	verzinkt	VDPS2825

## Heco Senkkopfschrauben

### TEILGEWINDE



MAßE	MODELL	KBN
4,5 x 45 mm	TOPIX-plus	HTOPPST4545
4,5 x 50 mm	TOPIX-plus	HTOPPST4550
4,5 x 70 mm	TOPIX-plus	HTOPPST4570
4,5 x 80 mm	TOPIX-plus	HTOPPST4580
5,0 x 100 mm	TOPIX-plus	HTOPPST50100
6,0 x 120 mm	TOPIX-plus	HTOPPST60120
6,0 x 140 mm	TOPIX-plus	HTOPPST60140
6,0 x 160 mm	TOPIX-plus	HTOPPST60160
6,0 x 180 mm	TOPIX-plus	HTOPPST60180
8,0 x 260 mm	TOPIX-plus	HTOPPTT80260
8,0 x 280 mm	TOPIX-plus	HTOPPTT80280
8,0 x 300 mm	TOPIX-plus	HTOPPTT80300
8,0 x 320 mm	TOPIX-plus	HTOPPTT80320

## Heco Bits

### TEILGEWINDE



MAßE	MODELL	KBN
HD 20 x 25 mm	Farbring orange	HBITHD20
HD 30 x 25 mm	Farbring gelb	HBITHD30
HD 20 x 70 mm	Farbring orange lang	HBITHD20L
HD 30 x 70 mm	Farbring gelb lang	HBITHD30L

## Seitenfalzklammer

## FÜR DIVERSE TONZIEGEL



## MODELL

Nr. 452/8 eckig ZIAL f.40 x 60 Latten  
 Nr. 452/6 eckig ZIAL f.30 x 50 Latten  
 Nr. 456 4/2,2 mm eckig ZIAL  
 Nr. 456 5/2,5 mm eckig ZIAL  
 Grad- u. Kehlklammer V2A 13-17 mm  
 poesis annex First-Gratnagel 210 x 40 mm  
 verzinkt

## KBN

SKL4528ZI  
 SKL4526ZI  
 SKL456422ZI  
 SKL456525ZI  
 GKK17  
 POANGN2140VZ

## Reparaturband

## ALUFARBIG



## MAßE

100 mm

## MODELL

Bitumenfrei, Rolle 10 m

## KBN

KEBUREP100

## Poesis Spachtel- und Metallkleber

## ELASTOPLASTISCH



## MAßE

12 kg

## MODELL

Klebe- und Dichtungsmasse

## KBN

POFISMK12

## ALLROUNDKLEBER



## MAßE

310 ml

## MODELL

Orcon F Kartusche

## KBN

ORCONF310

## DICHTMASSE POESIS-TENAX KLAR



## MAßE

300 ml

## MODELL

Kartusche

## KBN

SDMK

## ABSORBERGRANULAT

## FLECK



## MAßE

1 l

## MODELL

Roof Super Dry

## KBN

FROOFSUPERDRY

## Soudaband Pro

	MAßE	MODELL	KBN
	15/2-6	Kompriband anthrazit	SBANDBG11526A
	15/6-15	Kompriband anthrazit	SBANDBG115615A

## Profi Silikon

PRO N	MAßE	MODELL	KBN
	310 ml	schwarz	POPSILISW
	310 ml	transparent	POPSILITT

## Fix ALL

FÜR ALLE ANWENDUNGEN	MAßE	MODELL	KBN
	290 g	Turbo Kleb- und Dichtstoff weiß	DKLFIXW290
	470 g	Flexi Kleb- und Dichtstoff schwarz	DKLFIXSW470

  
**SOUDAL**

## Prefa Spezialklebeset

### SET



#### MODELL

Spezialkleber 290ml, Haftreiniger 60ml, Schleifpapier, Reinigungstuch, 2 Adapterdüsen

#### KBN

PRSPKL

## Lötwasser



#### MAßE

1 kg

1 kg

150 ml

#### MODELL

ZD Zink DIN EN29454.1

DIN EN29454.1 f. Zink und vorbewittert

Lötwasserpinsel

Salzsäureflasche blau

#### KBN

LOETWAZD1000

LOETWAZDP1000

LTWP

SALZFLBL150

## Zinn

### ZINN



#### MAßE

250 gr

250 gr

#### MODELL

35 % Dreikantstange

40 % Dreikantstange für Cu u. Zn

#### KBN

ZINN35

ZINN40

## Salmiakstein

### SALMIAK



#### MAßE

65 x 45 x 20 mm

#### MODELL

#### KBN

SALM

## Reinigungsvlies

### VLIES



#### MAßE

10 Stück

#### MODELL

metallfrei

#### KBN

VLIES

## Stehfalz- Zubehör

	MAßE	MODELL	KBN
	18 m	Dichtungsband für Stehfalzdeckungen	ILLMODX
	25 x 90 mm	Schiebehafte	ESHM
	25 x 30 mm	Festpunkthafte	EFHM
	28 mm	Festhafte H für Scharbefestigung	EFHMH
	28 mm	Schiebehafte für Scharbefestigung	ESHMH
	28 x 30 mm	Festpunkthafte	EFHM28
	28 x 90 mm	Schiebehafte	ESHM28
	4 x 30 mm	Clipfix Schrauben magaziniert Stahl	CLIPFIXS430MAW

## Bautenschutzmatte

GUMMIGRANULAT			
	MAßE	MODELL	KBN
	2000 x 1000 x 0,6 mm	Bauten- Isolierschutzplatte	BSP6
	2000 x 1000 x 0,8 mm	Bauten- Isolierschutzplatte	BSP8
	2000 x 1000 x 1,0 mm	Bauten- Isolierschutzplatte	BSP10

## TECGET-SAT

STAHL VERZINKT			
	MAßE	MODELL	KBN
	45 mm	Dachsparrenhalter f.Sparrenabstand 500-900 mm, 90 cm Mast	QGCSATADS

## HT Kunststoffübergang













KUNSTSTOFF			
	MAßE	MODELL	KBN
	110 x 100 mm	HT Kunststoffübergang Regenfallrohr	HTUE

## Vlies

POLYESTER			
	MAßE	MODELL	KBN
	2,2 x 50 m	Polyestervlies 300 g/qm bohrfest	PVLIES3002250



## Grün Brenner Zubehör

	MODELL	KBN
	Universal-Brenner-Handgriff mit Schnellschaltautomatik	GRUBHG
	Dreh-Schnellkupplung Brenngas komplett zum Verschrauben	GRSKK
	Kupplungs-Stift G 3/8" verstärkte Ausführung	GRKUST
	Kleinstflasche f. 0,425 Kg für Propangas	GRGF425
	Weichlöt-Set Prop 2 mit Transportkoffer	GRLOETSET2
	Hammer-Lötkolben 350 g gerade	GRHALK350G
	Federstuetze komplett mit Befestigungsmaterial	GRFEDERST
	Kleinbrenner K 35/400 Heizleistung 18,1 kW	GRKLBR35400
	Starkbrenner St 65/800 Heizleistung 119,4 kW	GRSTBR65800
	Hochdruck-Schlauch 4 bar mit Mitteldruck-Regler 10 m SBS	GRHDSCH10MDR
	Hochdruck-Schlauch 4 bar mit Mitteldruck-Regler 5 m SBS	GRHDSCH5MDR
	Regler 1,5 bar M Sbs 3 Kg Bds. Ersteinlagerung 3/8" links für Kleinflaschen	GRREGL15L

# GRÜN



# BESTELLÜBERSICHT

## Weitere Partner

